

CM2125

COMPUTER MONITOR ANALYZER

Operation and Application Manual

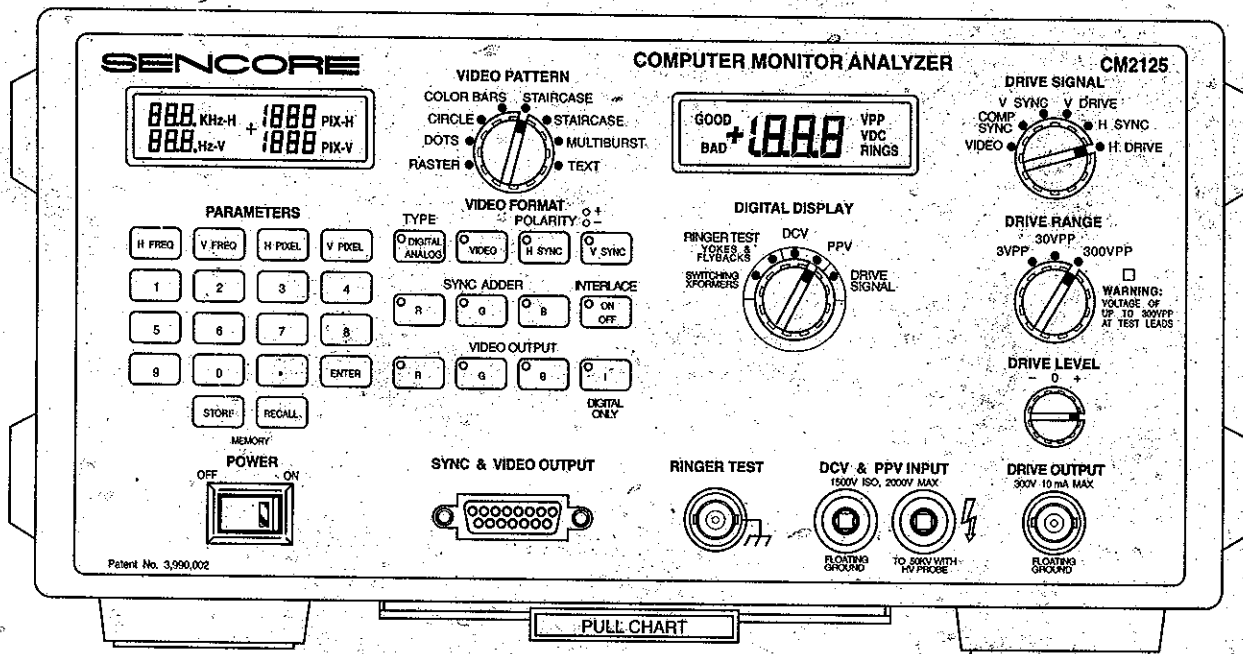

SENCORE

3200 Sencore Drive, Sioux Falls, South Dakota 57107

CM2125

COMPUTER MONITOR ANALYZER

Operation and Application Manual

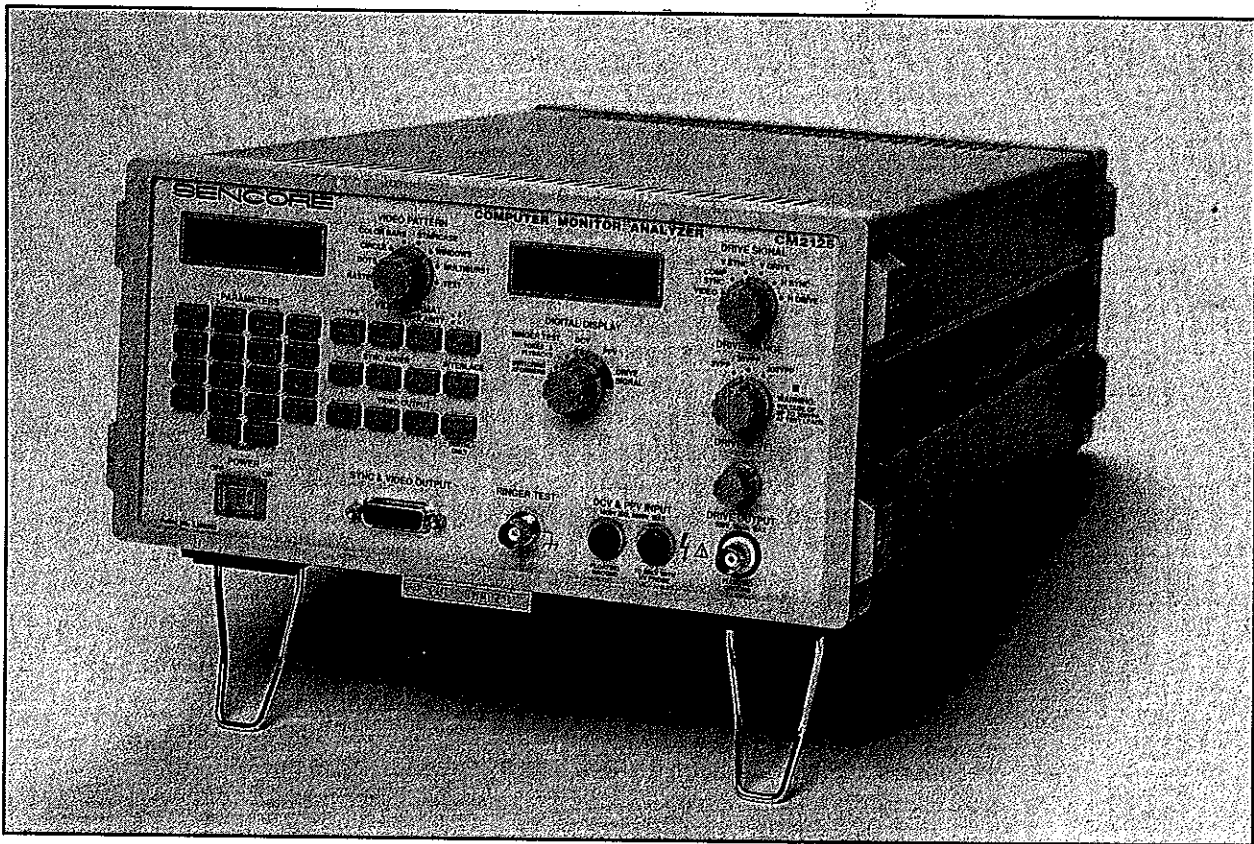

SENCORE

3200 Sencore Drive, Sioux Falls, South Dakota 57107

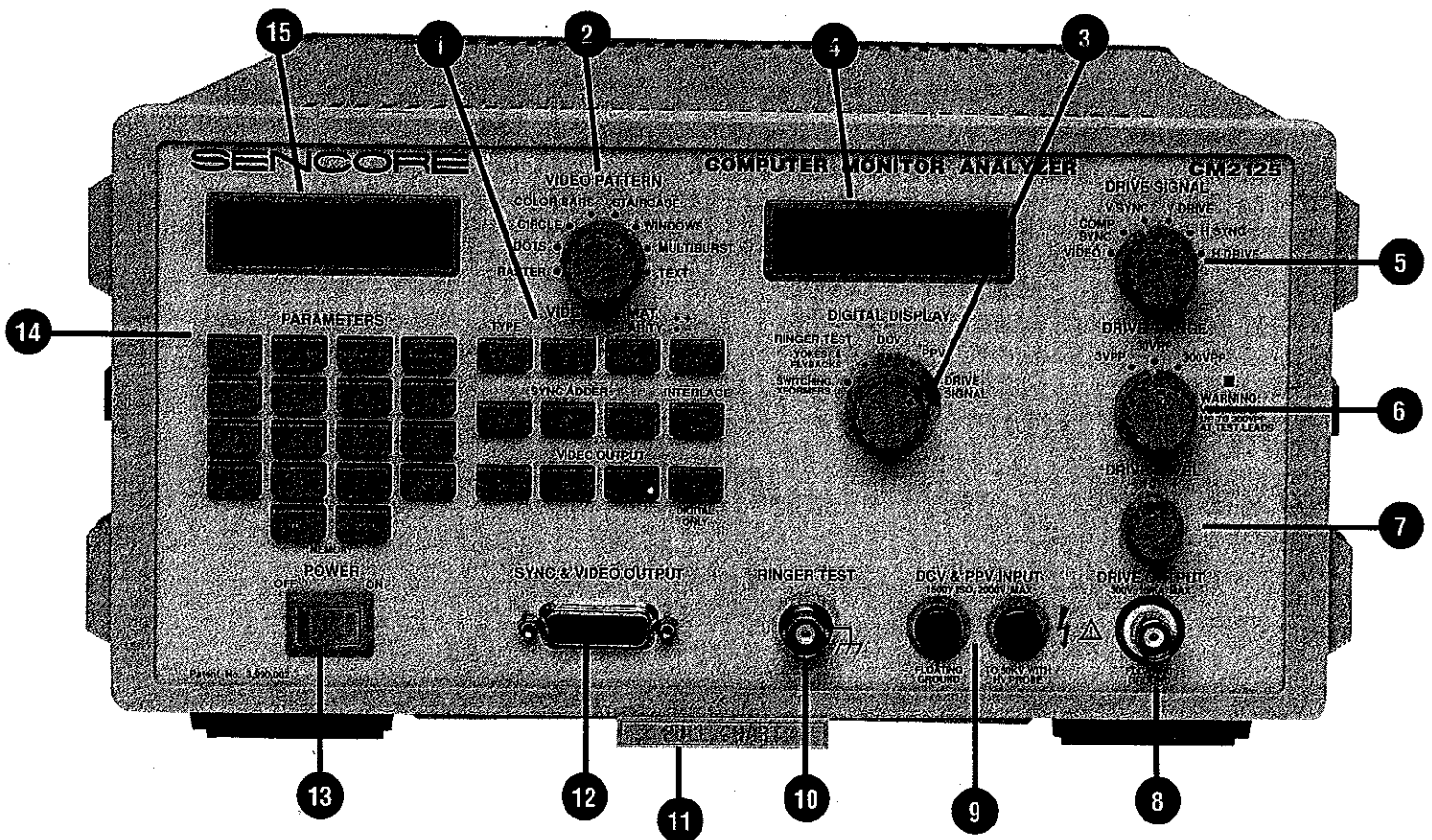

FRONT PANEL FEATURES

1. **VIDEO FORMAT Buttons** - Use to set the makeup of the video signal at the SYNC & VIDEO OUTPUT Jack (12). Push to activate and deactivate. Button is activated when the LED indicator in upper left corner lights. Setups may be stored and recalled with PARAMETER MEMORY Buttons (14g & 14h).

- a. **TYPE** - Use to select digital TTL or analog signal type. Indicator lights to signify "DIGITAL" and is off for "ANALOG."
- b. **POLARITY** - Use to set polarity of R, G, B & I signals ("VIDEO"), horizontal sync ("H SYNC"), and vertical sync ("V SYNC"). Indicator lights to signify positive polarity ("+") and is off to signify negative ("-") polarity.
- c. **SYNC ADDER** - Adds composite sync signal to selected video line. Indicator lights to signify which line(s) sync is added to.
- d. **INTERLACE** - Turns interlace sync on (indicator lit) and off.
- e. **VIDEO OUTPUT** - Turns R, G, B and I output lines on or off. Indicator lights when line is on.

2. **VIDEO PATTERN Switch** - Determines the video pattern at the SYNC & VIDEO OUTPUT Jack (12) that will be displayed on the monitor. Also selects the video pattern at the DRIVE OUTPUT

Jack (8) when the DRIVE SIGNAL Switch is set to "Video" (5a). Change the color of the pattern with the "Video Output" Format Buttons.

- a. **RASTER** - Provides a solid raster inside a framed border to test power supply regulation, purity and CRT phosphor.
- b. **DOTS** - Provides a grid of regularly-spaced dots to test dynamic convergence.
- c. **CIRCLE** - Provides a pattern of circles and lines to test linearity.
- d. **COLOR BARS** - Provides a sequence of colored bars to test the monitor's ability to produce color.
- e. **STAIRCASE** - Provides a 16-step staircase pattern to test gray scale and video linearity.
- f. **WINDOWS** - Provides a pattern consisting of 5 boxes - 1 in each corner and 1 in the center of the raster. Use to test power supply regulation and brightness uniformity.
- g. **MULTIBURST** - Provides a pattern consisting of 5 patches - 1 in each corner and 1 in the center of the raster. Each patch has horizontal and vertical lines that are 1, 2, 3 & 4 pixels wide, use to test the monitor's bandwidth and resolution.
- h. **TEXT** - Provides a full raster of text characters for checking focus and complete performance.

- 3. DIGITAL DISPLAY Switch** - Use to select the desired analyzer test function. Test results are displayed on the DIGITAL DISPLAY Readout (4).
- SWITCHING XFORMERS RINGER TEST** - Use with RINGER TEST Jack (10) and DIRECT TEST Lead (20) to check switching transformers for shorted turns.
 - YOKES & FLYBACKS RINGER TEST** - Use with RINGER TEST Jack (10) and DIRECT TEST Lead (20) to check deflection yokes and flyback transformers for shorted turns.
 - DCV** - Measures DC voltage applied to DCV & PPV INPUT Jack (9).
 - PPV** - Measures peak-to-peak voltage applied to DCV & PPV INPUT Jack (9).
 - DRIVE SIGNAL** - Measures peak-to-peak amplitude of internal Drive Signal available at DRIVE OUTPUT Jack (8).
- 4. DIGITAL DISPLAY Readout** - Displays results of tests selected by the DIGITAL DISPLAY Switch (3).
- 5. DRIVE SIGNAL Switch** - Determines the signal available at the DRIVE OUTPUT Jack. The sync frequencies are set by the PARAMETERS Buttons.
- VIDEO** - Provides a video signal to inject in the video circuits.
 - COMP SYNC** - Provides a vertical and horizontal sync only signal to inject before the sync separator.
 - V SYNC** - Provides a vertical sync signal to inject before the vertical oscillator.
 - V DRIVE** - Provides a vertical drive signal to inject after the vertical oscillator.
 - H SYNC** - Provides horizontal sync signal to inject before the horizontal oscillator.
 - H DRIVE** - Provides a horizontal drive signal to inject after the horizontal oscillator.
- 6. DRIVE RANGE Control** - Provides a coarse level adjustment of 3, 30 or 300 VPP for signals selected by the DRIVE SIGNAL Switch (5).
- 7. DRIVE LEVEL Control** - Provides fine level adjustment and polarity control of signals selected by DRIVE SIGNAL Switch (5).
- 8. DRIVE OUTPUT Jack** - Provides Drive Signal selected by DRIVE SIGNAL Switch (5). Use with DIRECT TEST LEAD (20).
- 9. DCV & PPV INPUT Jacks** - Provides connection to measure external DCV or PPV. Use with DVM TEST LEADS (21)
- 10. RINGER TEST Jack** - Provides connection for performing Ringer test. Use with DIRECT TEST LEAD (20).
- 11. PULL CHART** - Provides simplified instructions and setups.
- 12. SYNC & VIDEO OUTPUT Jack** - Provides video and sync signals selected by the VIDEO PATTERN Switch (2) with the parameters determined by the PARAMETERS Buttons (14) and VIDEO FORMAT Buttons (1).
- 13. POWER SWITCH** - Applies and removes AC power to the CM2125.
- 14. PARAMETERS Buttons** - Use to establish the correct numerical parameters of the RGB video signal at the SYNC & VIDEO OUTPUT Jack (12) to match the monitor being serviced.
- H FREQ** - Sets horizontal scan frequency from 10 to 250 kHz.
 - V FREQ** - Sets vertical scan frequency from 50 Hz to 250 Hz.
 - H PIXEL** - Sets number of horizontal pixels from 80 to 2048.
 - V PIXEL** - Sets number of vertical pixels from 80 to 2048.
 - DIGITS (0-9)** - Use with "Freq" and "Pixel" buttons (14a-d) to enter numerical value.
 - ENTER** - Press after numerical value to complete entry.
 - STORE** - Stores Parameter and Video Format setups in non-volatile User Memory locations 43 to 69 for later use.
 - RECALL** - Recalls preset setups from any memory location.
- 15. PARAMETERS Readout** - Displays active parameters and entries made using PARAMETERS Buttons (14).

REAR PANEL FEATURES

16. INTERFACE ACCESSORY Jack - Provides a connection for the optional IB72 IEEE 488 Bus Interface Accessory (30) or IB78 RS232 Interface Accessory (31).

17. RINGER FUSE - Protects Ringer test circuitry from external voltage. Replace with 0.5 AMP, 250 Volt, Fast-Blo, Type 3AG.

18. AC LINE FUSE - Protects unit from damage due to internal problems that cause excessive current draw. Replace with 1 amp, 250 volt Slo-Blo, type 3AG.

19. AC POWER CORD - Connect to a 105-125 VAC, 50/60 Hz, 60 watt source.

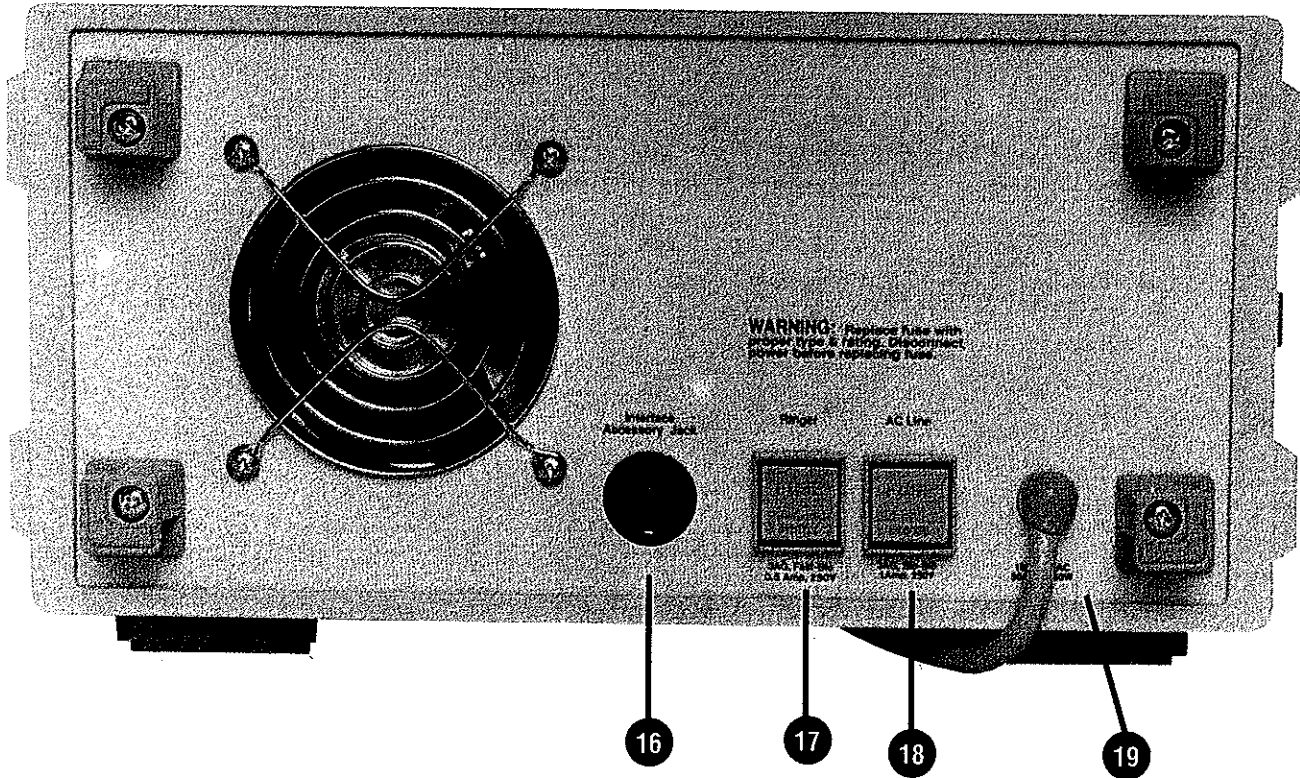

SUPPLIED ACCESSORIES

20. DIRECT TEST LEAD (39G221) - Use to connect the RINGER TEST Jack (10) to the component under test. Also use to connect the DRIVE OUTPUT Jack (8) to the circuit.

21. DVM TEST LEADS (39G264) - Provides a connection between DCV & PPV INPUT Jacks (9) and circuit.

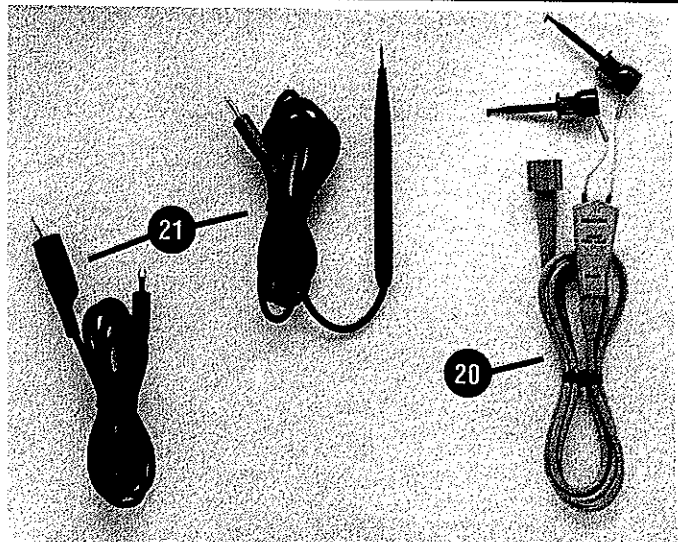

OPTIONAL ACCESSORIES

22. **EXTENSION CABLE (39B271)** - Provides an extension cable for the SYNC & VIDEO Output Jack (12) (48 inches).

23. **UNIVERSAL CONNECTOR (39B273)** - Cable connects to SYNC & VIDEO OUTPUT Jack to provide a connection to monitors having non-standard connectors. (12 inches).

24. **CONNECTOR #1 (39B275)** - Adapter connects between the SYNC & VIDEO OUTPUT Jack and the input cable of CGA, MDA and Hercules type monitors.

25. **CONNECTOR #2 (39B280)** Adapter connects between the SYNC & VIDEO OUTPUT Jack and the input cable of EGA type monitors.

26. **CONNECTOR #3 (39B281)** - Adapter connects between the SYNC & VIDEO OUTPUT Jack and the input cable of PGC type monitors.

27. **CONNECTOR #4 (39B274)** - Adapter connects between the SYNC & VIDEO OUTPUT Jack and the input cable of VGA, PS/2[®], SVGA and XGA type monitors.

28. **CONNECTOR #5 (39B276)** - Adapter connects between the SYNC & VIDEO OUTPUT Jack and the female input of Apple[®] and Macintosh[®] type monitors.

PS/2[®] is a registered trademark of IBM.

Apple[®] and Macintosh[®] are registered trademarks of Apple Computer Inc.

29. **CONNECTOR #5F (39B356)** - Adapter connects between the SYNC & VIDEO OUTPUT Jack and the male input of Apple[®] and Macintosh[®] type monitors.

30. **CONNECTOR #6 (39B272)** - BNC cable connects to SYNC & VIDEO OUTPUT Jack to provide a connection to monitors having BNC input connectors (48 inches).

31. **ECL ADAPTER (39G346)** - Converts the CM2125's digital video output to ECL video output.

32. **IB72 IEEE-488 BUS INTERFACE ACCESSORY** - Connects between the INTERFACE ACCESSORY Jack (16) and the IEEE-488 port of a bus controller to provide IEEE Bus operation.

33. **IB78 RS232 INTERFACE ACCESSORY** - Connects between the INTERFACE ACCESSORY Jack (16) and the RS232 serial port of a computer to provide automated testing and programming.

34. **PC263 PROTECTIVE COVER** - Snap-on cover protects front panel and provides Test Lead and Interface Connector storage.

35. **HP200 50 kV HIGH VOLTAGE PROBE** - Use with DVM TEST LEADS (21) to extend the DCV measuring range to 50 kV.

36. **TP212 10 kV TRANSIENT PROTECTOR PROBE** - Use with DVM TEST LEADS (21) to extend the DCV measuring range to 10 kV.

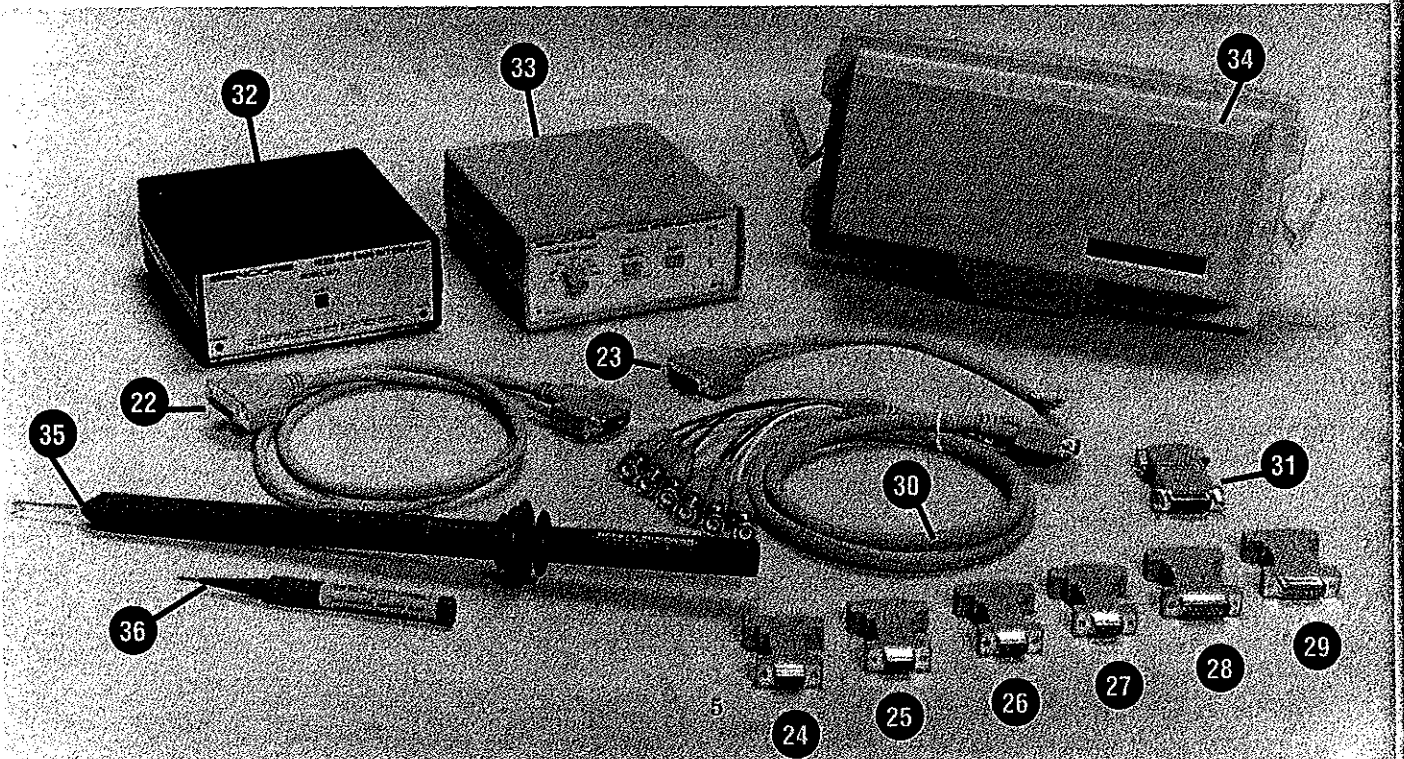

SPECIFICATIONS

All specifications allow for 20 minutes warm-up and are guaranteed at 15-35 degrees C (59-95 degrees F).

Sync & Video Output

VIDEO BANDWIDTH: 125 MHz

HORIZONTAL SYNC:

RANGE: 10.0 KHz to 250 KHz

ACCURACY: +/- 200 nSec

STEPS: 10.0 KHz to 99.9 KHz, .1 KHz
and 100 KHz to 250 KHz, 1 KHz

LEVEL: 5 VPP

POLARITY: (+) or (-)

VERTICAL SYNC:

RANGE: 10.0 Hz to 250 Hz

ACCURACY: +/- (1/H FREQ)*(6)

STEPS: 10.0 Hz to 99.9 Hz, .1 Hz
and 100 Hz to 250 Hz, 1 Hz

LEVEL: 5 VPP

POLARITY: (+) or (-)

COMPOSITE SYNC:

LEVEL: 5 VPP

POLARITY: (-)

HORIZONTAL RESOLUTION:

RANGE: 80 pixels to 2,048 pixels in one pixel steps

VERTICAL RESOLUTION:

RANGE: 80 pixels to 2,048 pixels in one pixel steps

MEMORY:

70 computer monitor setup storage locations.

VIDEO:

VIDEO PATTERNS: raster, dots, circle, color bars, staircase, windows, multiburst and text

DIGITAL

LEVEL: 5 VPP

PATTERN POLARITY: (+) or (-)

VIDEO POLARITY: (+) or (-)

VIDEO OUTPUT: red, green, blue and intensity.

ANALOG

LEVEL: 1 VPP, white level .714 V, black 0.0, and sync -.286 into 75 ohms.

PATTERN POLARITY: (+) or (-)

SYNC ADDER: red, green, blue

MODE: Non-interlace or interlace

VIDEO OUTPUT: red, green, blue

SYNC TIMING: The CM2125 recognizes common computer monitor formats and adjusts the sync time, front porch and back porch.

SYNC TIMING DEFAULT: If the CM2125 does not recognize the computer monitor format it sets the output to 80% displayed video and 20% sync. The sync pulse is divided into thirds between the front porch, blanking and back porch.

SYNC TIMING PROGRAMMING: Sync timing parameters can be set through the front panel or the IEEE 488 or RS232 interface buses.

HORIZONTAL

Minimum blanking time is 1.5 uSec. Minimum sync time is 0.3 uSec.

VERTICAL

Minimum blanking time is 1/H freq. Minimum sync time is 1/H freq.

Digital Display

RINGER TEST

INDUCTOR RANGE: 10 uH and larger, non-iron core

ACCURACY: +/- 1 count on readings between 8 and 13 rings

RESOLUTION: +/- 1 count

EXCITING PULSE: 5 volts peak, 60 Hz rate

YOKES & FLYBACKS

counts rings up to a 25% damping point

SWITCHING TRANSFORMERS

counts rings up to a 5% damping point

DC VOLTMETER

RANGES: Autoranging in three ranges, 0.00 to 19.99 V, 20.0 to 199.9 V and 200 to 1999 V

ACCURACY: +/- 0.5% +/- 2 counts

RESOLUTION: 10 mV on 20 V range, .1 V on 200 V range and 1 V on 2000 V range

INPUT IMPEDANCE: 15 megohms +/- 1%

AC REJECTION: Greater than 60 dB

PEAK-TO-PEAK VOLTMETER

RANGES: Autoranged in three ranges, 0.0 to 19.9 V, 20 to 199 V, 200 to 1999 V

ACCURACY: +/- 1% +/- 2 counts, +/- 5% +/- 5 counts in the 200 to 1999 V range

FREQUENCY RESPONSE: 30 Hz to 5 MHz +/- 1 dB on 20 V range, 30 Hz to 250 KHz +/- 1 dB on 199 V and 2000 V ranges

RESOLUTION: .1 V on 20 V range and 1 V on 200 V and 2000 V ranges

INPUT IMPEDANCE: 15 megohm shunted by less than 40 pF

PROTECTION: 2000 VDC (DC + peak AC) across inputs. Maximum voltage between (-) and ground = 1500 V (DC + peak AC).

Drive Signals

All drive signals are phase-locked to the SYNC & VIDEO OUTPUT.

SIGNALS AVAILABLE: video, composite sync, vertical sync, vertical drive, horizontal sync, horizontal drive

RANGE: 3 ranges, 0.0 to 3.0 VPP, 0 to 30 VPP and 0 to 300 VPP

ACCURACY: +/- 1%, +/- 2 digits for H DRIVE signal

FREQUENCY RESPONSE: 30 Hz to 5 MHz < 3 dB on 3.0 VPP and 30 VPP ranges. 30 Hz to 250 KHz < 3 dB on 300 VPP range.

OUTPUT: 3 VPP range, 3 VPP, +/- 0.5 V into 100 ohms circuit impedance, 30 VPP, +/- 5 V into 100 ohms circuit impedance, 300 VPP, +/- 50 V into 10,000 ohms circuit impedance.

PROTECTION: +/- 450 V (DC + peak AC)

General

DISPLAYS: LCD readout for FREQUENCY and PIXEL parameters. 3 1/2 digit LCD readout for DRIVE OUTPUT/DVM.

GUARANTEED OPERATING TEMPERATURE:

15 to 35 degrees Centigrade

WARM-UP TIME: 20 minutes

SIZE: 6" X 11.5" X 15" (15.2 X 29.1 X 38.1 cm) HWD.

WEIGHT: 16 pounds (7.3 kg).

POWER: 105 to 125 VAC 50/60 Hz, 85 Watts.

All specifications are subject to change without notice.

OPERATION

INTRODUCTION

This portion of the manual explains how to prepare the CM2125 for operation, and describes how to use its controls and features. It contains 4 major sections: 1) Preparation For Use; 2) Connecting To A Monitor; 3) Troubleshooting And Analyzing, and 4) Computer Automated Operation.

Once you have become familiar with the features and operation of the CM2125, you can operate it using the information on the front panel and on the Pull Chart located beneath the unit. The APPLICATION portion of this manual includes specific application examples and troubleshooting procedures.

PREPARATION FOR USE

The CM2125 is ready for use when it is removed from its packing material and connected to a proper source of AC power. All the Supplied Accessories are in the same box as the CM2125. When you first unpack the unit, confirm that you have received all the Supplied Accessories listed on page 4. If any are missing, promptly notify the Sencore Service Department. (See inside back cover for their address and phone number).

Place the CM2125 in a convenient location that is within about 36 inches of the monitors that you will be servicing. This will provide an adequate work area while keeping the monitors close enough to use the test leads. Do not block the air vents located on the top and bottom rear of the unit.

Power Connection

The CM2125 is powered by a standard 105-125 VAC, 50/60 Hz, AC line (220 VAC optional). The power cord is not detachable and includes a third-wire safety ground. Do not defeat this third-wire ground as it is necessary for proper shielding, operation and safety.

Optional 220 VAC Operation

If 220 VAC operation is needed, contact the Sencore Service Department for more information.

Power On Test

When the POWER Switch is turned on the CM2125 undergoes a power-on test sequence that lasts approximately 10 seconds. During this time all the indicator LEDs on the VIDEO FORMAT Buttons should sequence "on" and all the annunciators in the LCD Readouts should turn on. If any of the LEDs or annunciators fail to turn on, the CM2125 requires service. When the readouts clear and reset to the selected functions, the CM2125 is fully operational. The CM2125 defaults to the VIDEO FORMAT and PARAMETER settings that were last used.

To operate the CM2125 from an AC line:

1. Connect the power cord to a properly grounded, 105-125 VAC, 85 W AC power source. (220 VAC optional)
2. Press the POWER Switch on the front of the CM2125 to "On." The switch will illuminate to show that the unit is receiving power. If the light does not illuminate:
 - a. Confirm that the AC power source is correct
 - b. Check the CM2125 AC line fuse located on the rear of the unit.
3. Confirm that all VIDEO FORMAT Button LED Indicators and LCD Readout annunciators turn on.
4. Allow approximately 10 seconds for the internal circuitry to reset after applying power.

CAUTION

Defeating the 3rd wire safety ground connection may cause the CM2125 to operate incorrectly and may cause damage to it.

AC Line Fuse - An AC line fuse, located on the rear of the unit, protects the unit from excessive damage caused by an internal failure. The proper fuse value is 1 amp, 250 volt, Slo-Blo, type 3AG. If the fuse blows, locate the cause of the problem and correct it before replacing the fuse. Only replace the fuse with another of the same type and rating. Installing an incorrect fuse may damage the unit and will void all warranties.

To replace the AC line fuse:

1. Press to release the snap-in fuse holder.
2. Pull the holder and the fuse out of the fuse holder base.
3. Replace the fuse with another of the same type and rating.
4. Insert the holder and fuse into the fuse holder base and snap it back into place.

CAUTION

The wrong AC line fuse may damage the CM2125. Replace only with a 1 amp, 250 volt, Slo-Blo, type 3AG.

ATTENTION

Remplacer les fusibles avec un type et une valeur qui convient. Déconnecter l'alimentation avant de remplacer les fusibles.

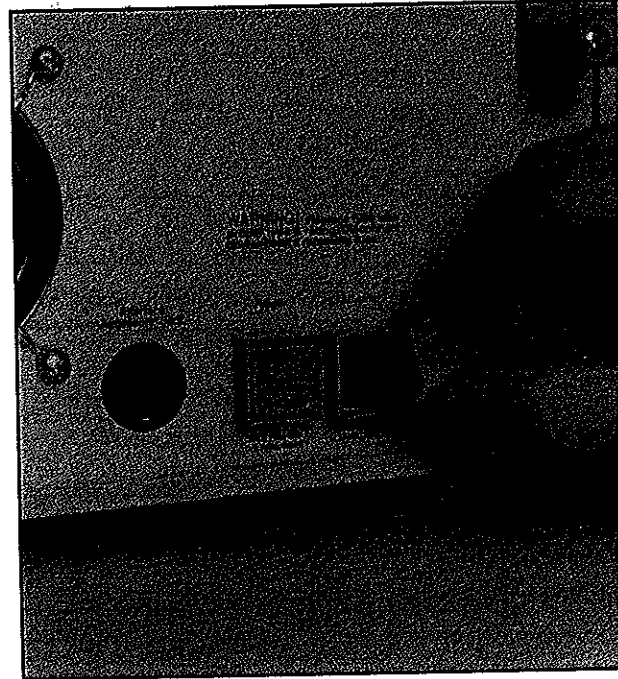

Fig. 1 If the CM2125 fails to power up when the POWER switch "on" check the AC line fuse.

CONNECTING TO A MONITOR

All the signal parameters generated by the CM2125, such as sync frequency, pixel resolution and polarity, can be set by the user. This is what gives the CM2125 the versatility to match any computer monitor. Connecting the CM2125 to a monitor requires four steps: 1) Choosing the proper Interface Connector; 2) Setting the Signal Parameters; 3) Setting the Video Format; 4) Selecting the Video Pattern. This section of the manual explains each of these steps.

WARNING

Many computer monitors use a full-wave "hot chassis". Always use an isolation transformer when servicing any monitor chassis. Failure to use isolation will produce a dangerous shock hazard and may result in damage to the monitor or your test equipment.

Do not isolate your test instruments as this may recreate the unsafe conditions.

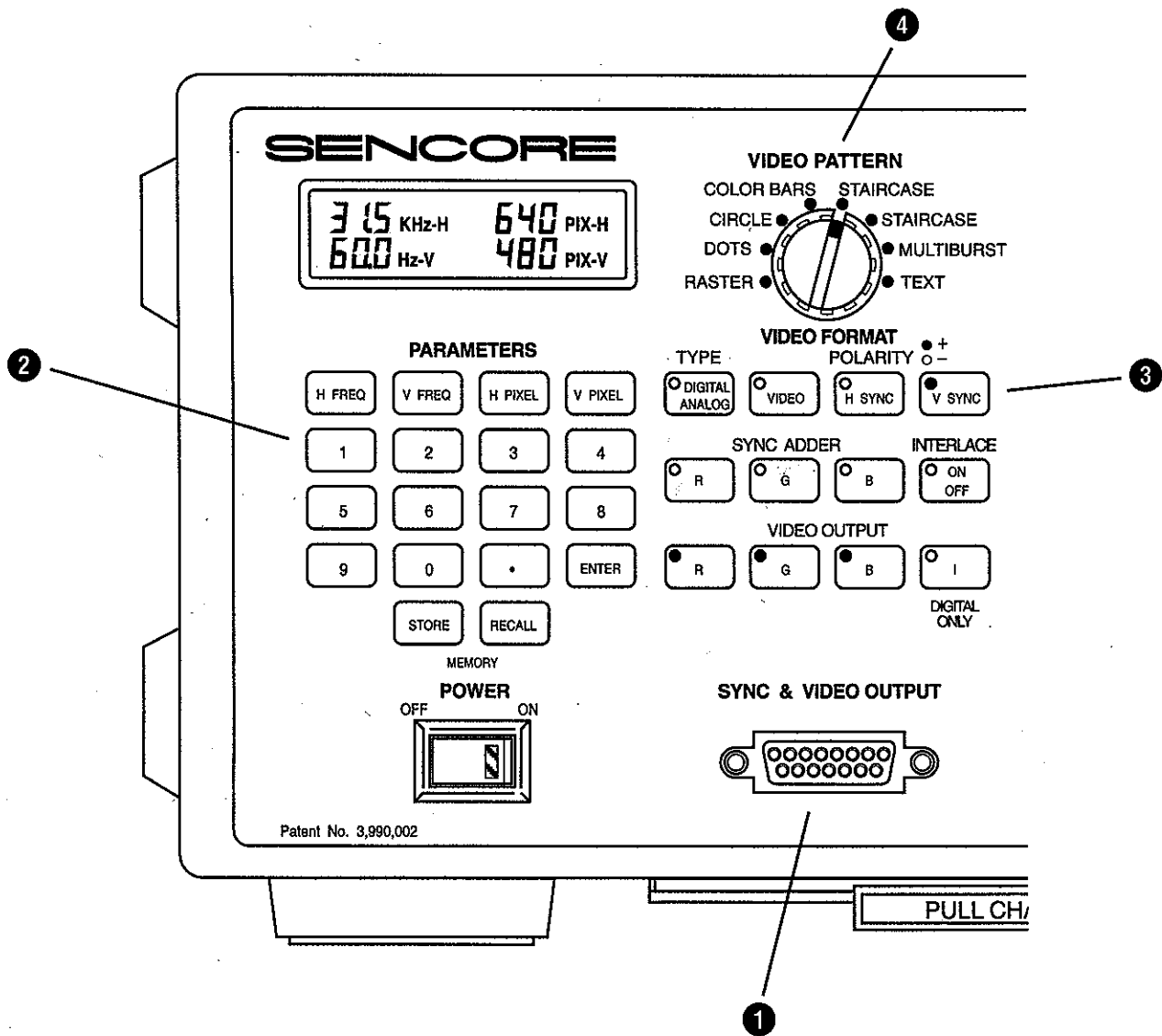

Fig. 2 Connecting the CM2125 to a monitor requires four steps: 1) Connect the proper Interface Connector; 2) Set the Signal Parameters, 3) Set the Video Format, and 4) Select the desired Video Pattern.

Choosing The Proper Interface Connector

Each type of computer monitor uses a unique "standard" connector. The connectors differ in size, shape, number of pins, and in electrical wiring. The (optional) Interface Connectors properly match the SYNC & VIDEO OUTPUT Jack to each monitor type. Table 1 lists the Interface Connector that is needed for each monitor type.



Fig. 3 Plug one end of the connector into the CM2125's SYNC & VIDEO OUTPUT Jack and the other end to the computer monitor's cable (or OUTPUT EXTENSION CABLE if the monitor does not have a cable).

The Interface Connectors may be ordered through Sencore Service Parts Department. Contact Service Department at:

**SENCORE SERVICE PARTS,
3200 Sencore Drive,
Sioux Falls, SD 57107
1-800-736-2673**

Note: Appendix C lists the wiring of the SY1 VIDEO OUTPUT Jack and Interface Connectors.

To connect the CM2125 to a monitor:

1. Turn "off" the Power Switch on both the CM2125 and the monitor.
2. Select the (optional) Interface Connector matches the monitor type you are servicing.
3. Plug the connector to the CM2125 SYNC VIDEO OUTPUT Jack.
4. Plug the monitor cable into the Interface Connector. Use the (optional) OUTPUT EXTENSION CABLE if the monitor does not have a cable, or if the cable is too short.
5. Turn "on" the Power Switch on both the CM2125 and the monitor.

CM2125 Connector Chart	
Connector	Computer Monitor Type
1	CGA, MDA, Hercules
2	EGA
3	PGC
4	VGA, PS/S, SVGA, XGA
5 & 5F*	Apple or Mac
6	BNC Input
ECL	ECL
Universal	Adapts to match any computer monitor type

TABLE 1 - Interface Connector applications

*Monitor with male Input connection

Setting The Signal Parameters

Each type of monitor (CGA, EGA, VGA etc.) operates at different horizontal and vertical scan frequencies and produces different amounts of horizontal and vertical resolution (pixels). Each of these monitor types has standard signal parameter values.

The parameter values for common monitors are summarized in Appendix D and on the Pull Chart. To make the monitor operate properly, you must enter the vertical and horizontal frequencies and pixel resolution shown. The PARAMETERS buttons select the frequencies and resolutions of the signals at the SYNC & VIDEO OUTPUT Jack and the frequencies of the DRIVE SIGNALS.

Some monitors are "multiscan" and can operate over a wide range of signal parameters. Test these monitors by selecting several different combinations of signal parameters that are within the monitor's operation range. Refer to the APPLICATION section entitled "Troubleshooting Multiscan Monitors" for more information.

PARAMETERS Readout - The LCD located directly above the PARAMETERS Buttons shows the current numerical value of each signal parameter. Figure 5 shows the information displayed by the Readout.

Monitor Type	H FREQ	V FREQ	H PIXEL	V PIXEL	DIGITAL ANALOG	H SYNC	V SYNC	Sync Adder	Interlace
CGA	15.7	60.0	640	200	DIGITAL	+	+	OFF	OFF
NEC DH	16.0	60.3	640	200	DIGITAL	+	-	OFF	OFF
HITACHI 2	17.3	62.4	512	512	ANALOG	+	-	OFF	ON
HERCULES	18.4	50.0	720	350	DIGITAL	+	-	OFF	OFF
MDA	18.4	50.0	720	350	DIGITAL	+	-	OFF	OFF
EGA	21.8	60.0	640	350	DIGITAL	+	-	OFF	OFF
NEC P2	24.8	56.4	640	400	DIGITAL	-	-	OFF	OFF
PGC	30.5	60.0	640	400	ANALOG	COMPOSITE SYNC		OFF	OFF
PGO	30	60	640	400	ANALOG	COMPOSITE SYNC		OFF	OFF

Fig. 4 Standard Monitor Formats (See Appendix D for a listing)

Note: The timing of the front porch, sync and back porch of the horizontal and vertical sync pulses match those of the standard computer monitor formats. As you are entering the parameters the CM2125 automatically checks to see if the format you've entered is a format it recognizes. If it is, the CM2125 automatically adjusts to the correct timing. If you deviate from any of the standard parameters, the blanking signal will default to 80% trace/20% retrace time. This may cause a noticeable change in the displayed raster size or position. To learn how to program the timing of the horizontal and vertical front porch back porch and sync signals, turn to page 14.

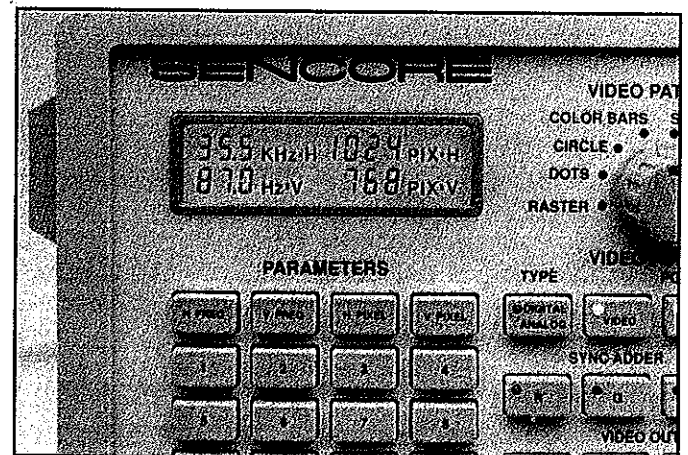

Fig. 5 The PARAMETERS READOUT shows the parameters of the output signals.

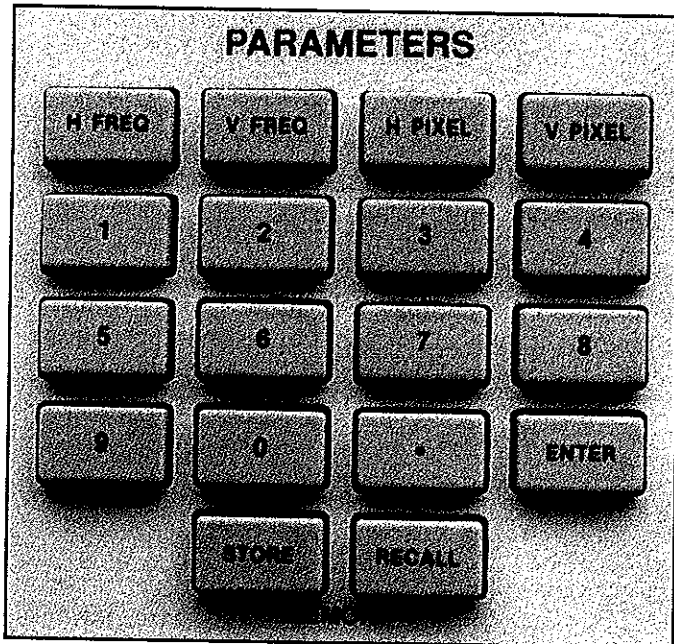

Fig. 6 The PARAMETERS buttons set the sync frequencies and pixels resolutions to match the monitor you are testing

SIGNAL PARAMETERS Buttons - Use the PARAMETERS Buttons to set the proper horizontal and vertical sync frequency and the number of horizontal and vertical pixels to match the monitor you are servicing. The PARAMETERS Buttons include:

- H FREQ** - horizontal sync frequency
- V FREQ** - vertical sync frequency
- H PIXEL** - horizontal pixel resolution
- V PIXEL** - vertical pixel resolution
- Digits 0-9** - numerical values

The "Store" and "Recall" Buttons are used with the memory functions. These are discussed later in the section entitled "Using The Memory Functions."

Entering a signal parameter requires three steps: 1) Push the desired parameter button, 2) Enter the numerical value, and 3) Press "Enter" to complete the entry. Watch the readings in the PARAMETERS Readout as you make the entry. When you push a PARAMETERS Button, the number portion of the corresponding display will blank and show each digit as you enter it. The parameter portion of the display will blink until you complete the entry by pressing "Enter." If you make a mistake while entering a number, simply press the previously selected parameter button and begin again.

The Parameter range limits that the CM2125 generate are:

- Vertical frequency - 10 Hz to 250 Hz
- Horizontal frequency - 10 kHz to 250 kHz
- Vertical Pixels - 80 to 2048
- Horizontal Pixels - 80 to 2048

To change a signal parameter:

1. Find the parameter values in the monitor service literature or in Appendix D.
2. Press the PARAMETER Button of the unit you wish to change. The corresponding PARAMETERS Readout display will blink.
3. Enter the numerical value using the DIGIT Buttons. Make sure that each number appears in the PARAMETER Readout.
4. Press "Enter" to complete the entry.

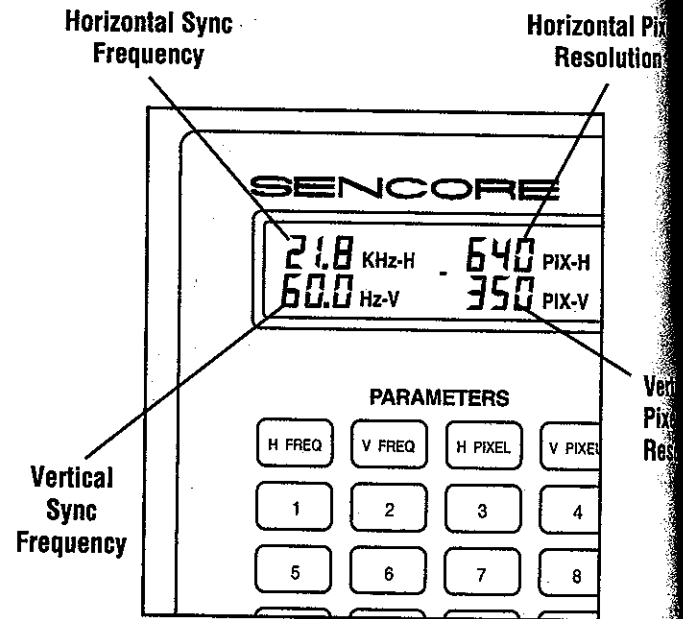

Fig. 7 Setting the CM2125 to generate the signals for an EGA monitor.

Example: programming the CM2125 to generate the correct signals for an EGA computer monitor.

1. Find the monitor's parameters in the service literature or in Appendix D.
2. Press

H FREQ	2	1	.	8
--------	---	---	---	---
3. Press

V FREQ	6	0	ENTER
--------	---	---	-------
4. Press

H PIXEL	6	4	0	ENTER
---------	---	---	---	-------
5. Press

V PIXEL	3	5	0	ENTER
---------	---	---	---	-------

Notes: (1) If you attempt to exceed either the frequency or pixel range limits, the entry will default back to the original value, (2) If you make an entry error, press the previously selected parameter button and repeat steps 3 and 4, (3) The CM2125 will return to the PARAMETERS settings last used before it was turned "Off" whenever you turn "On" the AC Power.

Monitor Format

The left LCD display on the CM2125 shows the computer monitor's format (horizontal and vertical pixels and scan frequencies). The CM2125 delivers as many pixels to the monitor as its bandwidth allows. For example, when the CM2125 is connected to a monitor with specifications of 2048 horizontal pixels and a horizontal scan frequency of 125 KHz, the CM2125 sends 936 pixels.

Note: See Appendix I for an explanation of the relationship between pixels, scan frequency, and dot clock frequency.

To determine the number of horizontal pixels generated by the CM2125:

1. Press

The number of horizontal pixels actually being generated by the CM2125 will appear for five seconds in the left LCD display.

Programming Sync Timing Parameters Into The CM2125

Importance of Proper Timing

The horizontal and vertical sync signals fed to a monitor are responsible for synchronizing the horizontal and vertical oscillators to the incoming video signals. The oscillators in turn feed the driver and output stages which move the electron beam up and down and back and forth across the face of the CRT.

The timing of the sync signals in relationship to the video establishes the position of the picture that is displayed on the CRT. If the sync and video timings are incorrect the displayed picture will be the wrong size, will be shifted up or down, or will be shifted to the left or right.

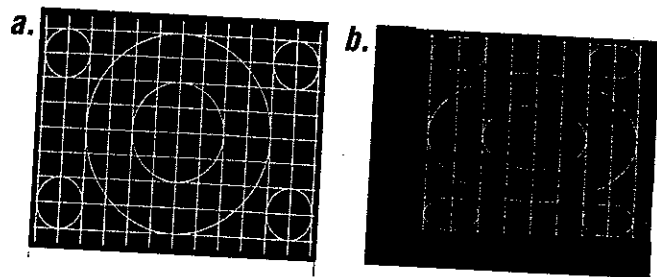

Fig. 9: (a) The display is properly sized and centered. (b) Display is shrunk and shifted because of incorrect timing between the sync signals and video.

Four Sync Parameters

The horizontal and vertical sync signals each have four parameters: front porch time, sync time, back porch time, and active video time. The combination of front porch, back porch, and sync times make up blanking time. Blanking time plus active video time equals the total scan time.

When To Program Sync Parameters

Memory locations 0-42 in the CM2125 contain the setups for the most common computer monitor formats. These setups contain the correct horizontal and vertical sync frequencies and pixel counts, as well as the timing parameters for vertical and horizontal front porch, sync, and back porch.

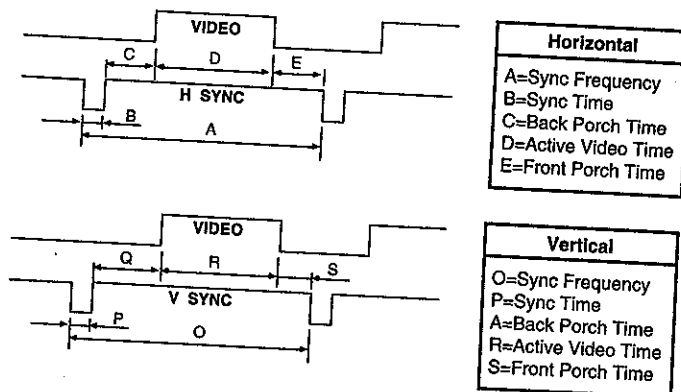

Fig. 10: Four timing parameters: front porch, sync, back porch, and active video, establish the size and centering of the raster on the CRT.

If you enter the scanning frequencies and pixel rates for a computer monitor format the CM2125 does not

recognize, the scan and sync parameters will automatically default to 80% displayed video and 20% blanking. The blanking pulse time will be divided evenly between the front porch, sync, and back porch. If the computer monitor does not use a 80% video 20% blanking timing format (with blanking divided into thirds), a locked in pattern will appear on the display, but it will not be centered.

You can center the pattern on the display by changing the timing of the vertical and horizontal front porch, back porch, and sync to the values the computer monitor has been designed to receive. You can change the timing of these parameters from the front panel of the CM2125.

Programming The Sync Time Parameters

In order to change any of the timing parameters, you must enter a series of keystrokes that puts the CM2125 into the "programming" mode. This is completed by pressing STORE, 8, 0, and then ENTER.

Press: 

Fig. 11: Keystrokes to place the CM2125 into the program mode.

When the CM2125 is in the "Program" mode, a small dot appears in the upper right hand corner of the left display. The dot remains in the display until RECALL, 8, 0, and ENTER are pressed again or until a setup from memory location 0-42 is recalled.

The dot also appears in the display when you recall a setup that you've previously programmed the timing parameters for and stored into the user memory locations. The dot reminds you the timing parameters have been programmed and that the CM2125 is generating these timing parameters.

To take the CM2125 out of the "Program" mode press RECALL, 8, 0, and then ENTER. The dot in the left hand display will disappear.

Press: 

Fig. 12: Keystrokes to take the CM2125 out of the program mode.

Once the CM2125 is in the program mode, you can start entering the timing values for the horizontal and vertical front porch, sync, and back porch parameters. The values you enter will appear in the right hand display located above the DIGITAL DISPLAY switch. The following key sequences are used to program vertical and horizontal sync time.

Programming Vertical Blanking Parameters:

Front Porch Time	Press	STORE	8	1	ENTER	"front porch time" (msec)	ENTER
Back Porch Time	Press	STORE	8	2	ENTER	"back porch time" (msec)	ENTER
Sync Time	Press	STORE	8	3	ENTER	"sync time" (msec)	ENTER

Fig. 13: Keystrokes for programming vertical timing parameters.

In the program mode, the vertical sync frequency is automatically calculated from the horizontal sync frequency, vertical pixel number, and sync time parameters you enter. If you attempt to set the vertical sync frequency while in the programming mode, the error code "E4" will appear in the right hand display.

Programming Horizontal Blanking Parameters:

Front Porch Time	Press	STORE	8	4	ENTER	"front porch time" (µsec)	ENTER
Back Porch Time	Press	STORE	8	5	ENTER	"back porch time" (µsec)	ENTER
Sync Time	Press	STORE	8	6	ENTER	"sync time" (µsec)	ENTER

Fig. 14: Keystrokes for programming horizontal timing parameters.

You must enter all three parameters (front porch, sync, and back porch) as a group for either vertical or horizontal sync timing before those parameters take effect. Once you have entered values for all three, you can go back and modify any of the three parameters individually.

If an "E 9" appears in the right hand display when you attempt to store a timing parameter, the "sync time" programming mode has not been enabled. Press: STORE, 8, 0, and then ENTER and begin again.

Storing The New Format

Once you have entered the timing parameters for the new setup, you can store them for future use. Storage locations 43-69 are available for user setups. All six timing parameters will be stored in the same memory location. The CM2125's memory is nonvolatile so the setup will not be lost when the unit is shut off or unplugged. To store the setup in the CM2125, enter the keystrokes shown below:

Press "memory location"
(43-69)

Fig. 15: Keystrokes for storing a programmed setup.

Checking A Timing Parameter

You may want to check the time you've entered for one of the parameters. This can be done by recalling the location where the parameter is stored. The value will appear in the right hand display. You cannot recall the timing values of the setups stored in memory locations 0-42. If you attempt to do this, three 8's will appear in the right hand display.

Press "location 81-86"

Fig. 16a: Keystrokes for recalling a stored timing parameter.

Press

Fig. 16b: Keystrokes to check the front porch time of the vertical blanking pulse.

Programming Example

The following chart contains the timing parameters for a computer monitor. Follow steps 1-9 to program this information into the CM2125. In this example, the setup is stored in memory location 49. When RECALL, 4, 9, and ENTER are pressed, the CM2125 will generate signals with the timing values you've programmed.

Parameter	Horizontal	Vertical
Frequency	65.2 kHz	61.7 kHz
Resolution	1024 Pixels	1024 Pixels
Front Porch	.360 μ Sec	.300 μ Sec
Sync	.770 μ Sec	.114 μ Sec
Back Porch	.770 μ Sec	.114 μ Sec
Polarity	+	+

1. Set to 65.2 kHz to 1024 to 61.7 Hz to 1024
2. Press ("scan time" program mode)
3. Press (vertical front porch)
4. Press (vertical back porch)
5. Press (vertical sync)
6. Press (horizontal front porch)
7. Press (horizontal back porch)
8. Press (horizontal sync)
9. Press (Store in Memory Location 49)

Setting The Video Format

Besides scan frequency differences, monitors vary in the makeup of the input signal, such as polarity, level and how the sync is applied. Additionally, many monitors can operate in several modes and use the polarity of the sync signals to figure out their operating mode. (Refer to the APPLICATION section entitled "Testing Mode Select Circuits" for details on multimode monitors).

The signal formats used by common monitors are shown in Appendix D and on the Pull Chart. The VIDEO FORMAT Buttons select the makeup of the signal at the SYNC & VIDEO OUTPUT Jack to allow the CM2125 to duplicate all monitor input requirements. The Formats can be changed using the front panel buttons, by recalling a stored setup from memory, or via the Computer Interface Bus. Following is a further explanation of each VIDEO FORMAT Button:

OUTPUT signals to digital levels (LED "on" analog levels (LED "off"). If you select the wrong TYPE, the monitor will display the video pattern incorrectly. (Refer to the section entitled "Video Patterns" on page 20).

A small percentage of high resolution computer monitors on the market require an ECL (emitter coupled logic) input. The CM2125 provides the I signal when used with the optional ECL adapter (39G346). The ECL adapter connects to the SYNC VIDEO OUTPUT of the CM2125 and converts digital signal levels to ECL signal levels.

To order the ECL adapter contact the Service Department at:

SENCORE SERVICE PARTS
 3200 Sencore Drive
 Sioux Falls, SD 57107
 1-800-736-2673



Type - Monitors require either digital, analog or ECL input signals. This switch sets all the SYNC & VIDEO

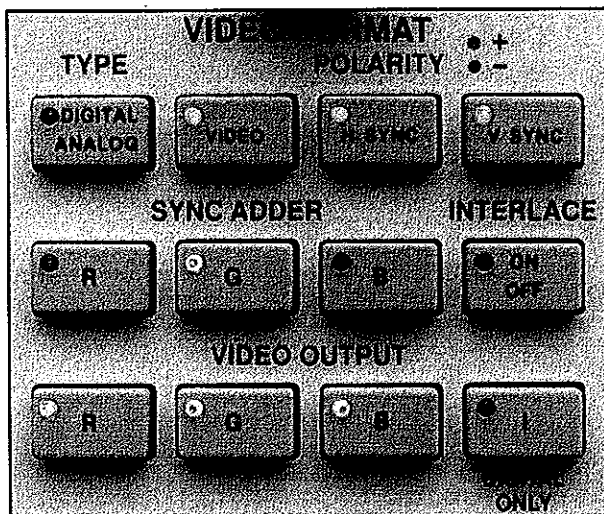
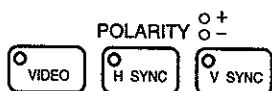

Fig. 8 The VIDEO FORMAT buttons control the makeup of the signals coming out of the SYNC & VIDEO OUTPUT Jack.



Polarity - The "Polarity" Format Buttons establish the polarity of the **VIDEO** (R, G, B & I), **H SYNC** (horizontal sync) and **V SYNC** (vertical sync) signals at the SYNC & VIDEO OUTPUT Jack. The LED Indicator lights for "+" polarity and is unlit for "-" polarity. The "Polarity" Button also changes the polarity of the "Video" DRIVE SIGNAL.

Most monitors require "+" Video polarity. Choosing the wrong polarity will produce a negative picture image on the monitor. Incorrect sync polarities may have no effect on some monitors and may cause loss of sync in others. Some monitors use different sync polarity combinations to select operating modes.

Video Polarity

The vast majority of the computer monitors on the market require a positive going video signal (white video level positive relative to blanking). A few computer monitor types require a negative going a video signal (white video level negative relative to blanking).

The CM2125 generates both the positive and negative polarity video signals

Example: programming the CM2125 to generate a negative polarity video signal.

1. Press



The LED on the DIGITAL/ANALOG button flashes when the CM2125 is generating a negative polarity video signal. If the CM2125 is generating a negative polarity video signal and you want to go back to a positive polarity video signal:

2. Press



3. Or recall a stored monitor format than doesn't require a positive polarity video signal.

The CM2125 stays in the negative polarity video signal mode when the unit is turned off and back on again. Also, if a monitor format is stored in one of the memory locations in the negative polarity mode, it will be in the same mode when the format is recalled.

Sync Adder - The sync adder buttons select to which video line the sync information is added. Selecting R, G, or B adds both the vertical and horizontal sync to that signal line. Sync is added to a line when the corresponding LED Indicator is lit. Sync can only be added to "Analog" type monitors.

Adding sync to a video line when it is not needed may change the background color or cause the picture to distort. Not adding sync to a video line that requires it will result in a raster that is out of sync.

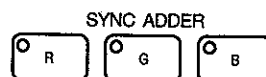

Interlace - This button switches the vertical sync between interlaced scan (LED "on") and progressive scan. Set it to match the monitor type you are servicing. Most monitor types use progressive scan (Interlace "off").

In non-interlace, all the vertical pixels are displayed each field. In the interlace mode, one half the vertical pixels are displayed each field. If the "Interlace" setting does not match the monitor type, the display will loose vertical sync or will have vertical raster distortion.



Video Output - Use these buttons to make the R, G, B, and I output lines active (LED "on") or inactive. Some digital monitors use the "I" (intensity) line to provide an additional signal level step between on and off. The "I" output can only be selected for "Digital" Type monitors. To produce normal B&W and color operation, all Video Outputs (R, G, and B) must be "on."



Using The Memory Functions

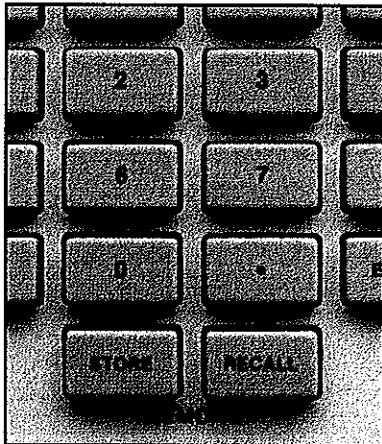

Fig. 17 - 70 Memory locations hold the most common monitor setups.

The CM2125's memory functions allow you to quickly recall a complete monitor setup, including the "Parameters" and "Video Format" settings, by entering the number of the desired setup. The memory presets consist of three groups: 1) Standard Setups, 2) User Setups, and 3) Computer Interface Setups. All the setups can be recalled from the front panel keypad, but only the "User Setups" can be programmed from the front panel.

Standard Setups (0-42) - Presets 0 through 42 are the setups for the most common monitor types. They are listed in Appendix E and in the pull chart beneath the unit. These setups are pre-programmed into permanent memory and cannot be erased or changed by the user.

User Setups (43-69) - Presets 43 through 69 can be programmed from the front panel keypad using the "Store" button. Use these presets to store special setups used in your servicing. The Pull Chart provides a place for you to write what you've stored under each number. The setups are stored in an E²PROM and will not be lost when power is turned off.

To recall a setup:

1. Press the "Recall" button. The PARAMETERS Readout annunciators will flash and the DIGITAL DISPLAY Readout will blank.

2. Enter the desired preset number. The will appear in the DIGITAL DISPLAY Readout.
3. Press the "Enter" button.

The CM2125 output signals are now set indicated parameters and format. Any of the may be altered using the front panel PARAM and VIDEO FORMAT Buttons.

Example: recalling the setup for an MDA monitor.

1. Find the setup storage location of an M monitor in Appendix E or the pull char
2. Press

The CM2125 is now generating the signals r by an MDA monitor.

To store a setup:

1. Set the "Parameters" and "Video Form the desired settings.
2. Press the "Store" button. The numbers PARAMETERS Readout will flash and DIGITAL DISPLAY Readout will blan
3. Enter the desired preset between 20 a The number will appear in the DIGITL DISPLAY Readout.

Note: Error "E 5" will appear in the D. DISPLAY Readout if you enter a number not between 43 and 69.

4. Press the "Enter" button.

The setup will overwrite the setup th: previously stored in the memory location a stay in memory until you change it.

Example: storing a setup you've just progr into the CM2125.

1. Choose an unused memory location (43 Let's say location "45".
2. Press

All of the settings in the PARAMETE VIDEO FORMAT sections have been st memory location "45". To recall these setti

3. Press

Selecting The Video Pattern

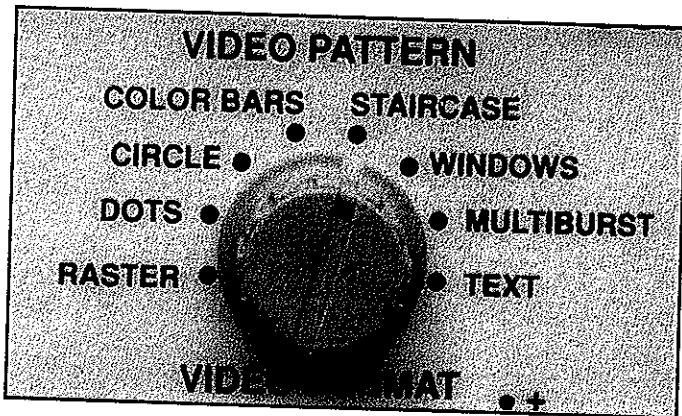

Fig. 18 The VIDEO PATTEN switch.

The VIDEO PATTERN Switch selects the RGB video signals at the SYNC & VIDEO OUTPUT Jack and the "Video" Drive Signal at the DRIVE OUTPUT Jack. Each pattern provides a special test of the monitor's operation. The "R," "G" and "B" VIDEO OUTPUT Buttons must be selected for a pattern to appear on the monitor. Turning any of these buttons "off" will change the displayed pattern. Unless otherwise noted, the patterns appear the same on both "Digital" and "Analog" monitor types. Following is a description of each pattern and its uses.

Note: Use the "+" Video Format unless you are using the Raster pattern to test high voltage regulation.

Raster - The Raster pattern produces a box, surrounded by a 1 pixel-wide border. Use this pattern to check color purity and high voltage power supply regulation. The box should be pure white with no color hue when all the "Video Output" Buttons are "on." It changes to black in "-" video polarity. In the "+" video polarity, the box edges should remain straight and ripple free. The outside white border should remain straight and unchanged in either video polarity.

Check color purity by turning each R, G, and B VIDEO OUTPUT "on", one at a time. For each color, the raster should be pure with no other color visible.

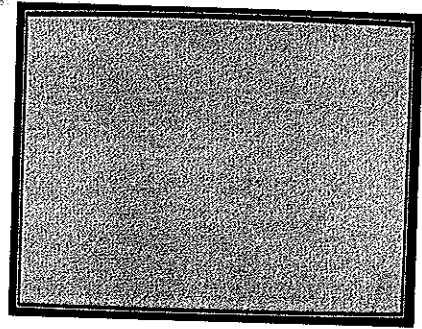

Fig. 19- The RASTER video pattern.

Dots - Use the DOTS pattern for checking static and dynamic convergence. Check for white dots with no visible color. A misconverged CRT will show colored dots, instead of white dots.

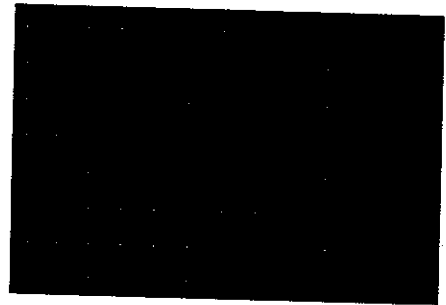

Fig. 20 - The DOTS video pattern.

Circle - The CIRCLE pattern provides a test of the monitor's linearity, and can be used to check dynamic convergence. Check that each line is straight and that each box is square and the same size throughout the raster. Also check that each circle is round with no visible distortion. If the CRT is converged properly, the lines will each be a single, white line instead of two or three colored lines.

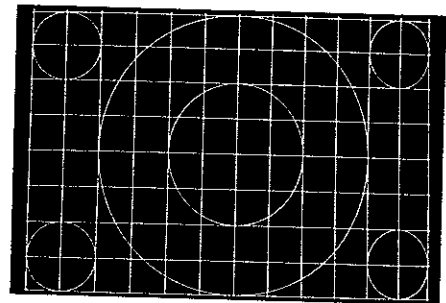

Fig. 21 - The CIRCLE video pattern.

Color Bars - The COLOR BARS pattern tests the monitor's ability to produce proper color. Check that each color bar is present. A missing bar, or wrong color sequence, may indicate that a video channel is connected incorrectly or is defective. Also check that the colors are uniform in intensity from top to bottom and left to right. Non-uniform bars may indicate problems in the video amplifiers.

The COLOR BARS sequence is shown in figure 14 ("+" video polarity) for "Analog" TYPE FORMAT. When the "Digital" TYPE is selected, the pattern changes slightly depending on the setting of the "I" line. With the "I" line "on," the bar sequence is similar to the "Analog" TYPE with the bottom row of bars being brighter than the top row. When the "I" line is "off," the top and bottom bars are the same brightness.

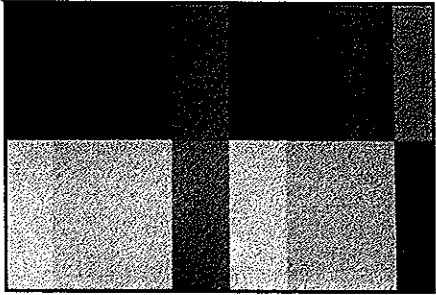

Fig. 22 - The COLOR BARS video pattern.

Staircase - The STAIRCASE pattern tests the brightness and contrast linearity of analog, and monochrome digital monitors. A properly working and adjusted analog or monochrome digital monitor will display 16 evenly spaced bars ranging from black to 100% white (or amber or green, depending on phosphor). Each step should have a sharp and distinct transition. The bars should be pure shades of gray with no hint of color.

Note: The STAIRCASE pattern is produced by changing the signal level on the RGB lines in 16 steps. Therefore, color digital monitors (which are only capable of 2 levels) will not reproduce this pattern. Instead, they will produce color bars having the same sequence as the bars in the COLOR BARS pattern except the top row of bars will be on the left half of the screen and the bottom row will be on right half of the screen.



Fig. 23 - The STAIRCASE video pattern (analog and monochrome digital monitors).

Windows - Use this pattern to test the monitor power supply regulation. Check for a clear, distinct transitions between the black and white portions. The white boxes should be the same brightness level and the entire screen should be free of ripple. The pattern should lock in with no "bounce" as you switch between "+" and "-" video polarity.

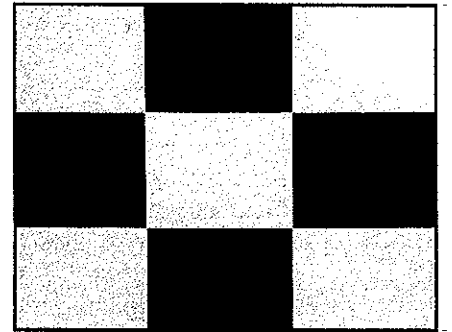

Fig. 24 - The WINDOWS video pattern.

Window - Monitor manufacturers often require the WINDOW pattern for making internal contrast and brightness adjustments. The WINDOW pattern is also helpful for brightness and color adjustments when the CM2125 is used together with a CRT Color Analyzer.

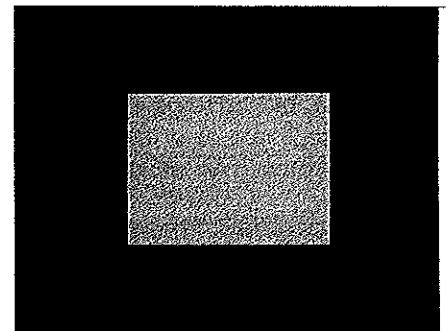

Fig. 25 - The WINDOW video pattern.

Example: changing the WINDOWS pattern to the WINDOW pattern.

1. Press

Now when you turn the VIDEO PATTERN knob to the WINDOWS video pattern a single window will appear in the center of the display. To change the CM2125 to again generate the WINDOWS pattern:

1. Press

Multiburst - The MULTIBURST pattern tests monitor resolution and bandwidth. The sets of vertical lines test horizontal pixel resolution and the sets of horizontal lines test vertical pixel resolution. The lines in each set are grouped according to pixel width. The lines in the first group are 1 pixel wide, the second group 2 pixels wide, the third group 3 pixels wide etc. The 1 pixel wide lines should be individually discernible on a properly operating monitor.

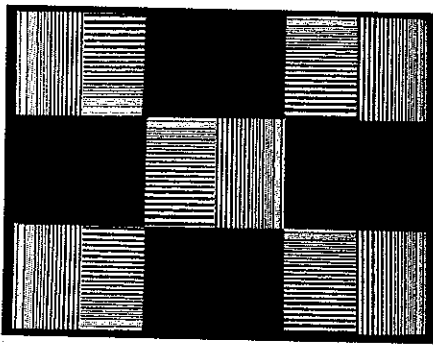

Fig. 26 - The MULTIBURST video pattern. The vertical lines test horizontal resolution and the horizontal lines test vertical resolution.

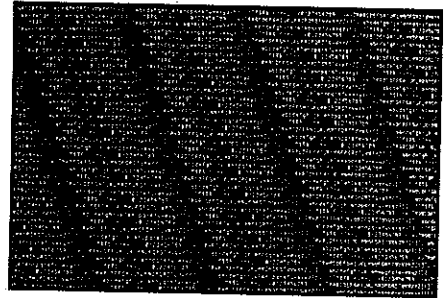

Fig. 27 - The TEXT video pattern.

Text - Use the TEXT pattern to make a final performance test on the monitor. This pattern fills the screen with upper and lower case text characters that duplicates user conditions. All the characters on the screen should be focused and easy to read.

TROUBLESHOOTING AND ANALYZING

The CM2125 provides special tests and signals to help you isolate problems to the defective stage. The Digital Display section provides a special Ringer test and signal measuring capabilities. The Drive Signal section provides signals to inject into the monitor circuits. This section explains how to use these troubleshooting and analyzing features of the CM2125. If you are not familiar with monitor troubleshooting, or need more information and examples on using the tests and Drive Signals, refer to the APPLICATIONS section of this manual.

Digital Display

The Digital Display section includes the DIGITAL DISPLAY Switch and the DIGITAL DISPLAY Readout. The DIGITAL DISPLAY Switch has three sections: 1) Ringer tests, 2) DVM, and 3) Drive Signal monitor. The DIGITAL DISPLAY Readout located directly above the switch shows the result of each test.

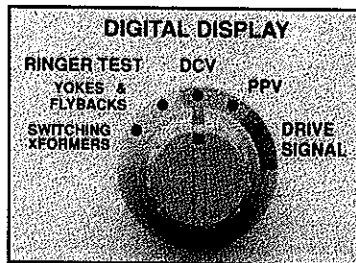

Fig. 28 The CM2125 provides tests and injection signals for troubleshooting defective monitors.

RINGER TEST

The Ringer Test detects shorted turns in deflection yokes, flyback transformers and IHVTs, and switching power supply transformers. It checks the coil's quality or "Q" and will locate shorted turns that cannot be detected by other troubleshooting methods. The Ringer test is the same patented test used in other Sencore Analyzers and "Z Meters."

Note: The Ringer Test may not show the same number of "Rings" as the Ringer in another Sencore unit. This is due to small variations in drive levels and autoranging steps. In all cases, coils with a shorted turn will read "Bad."

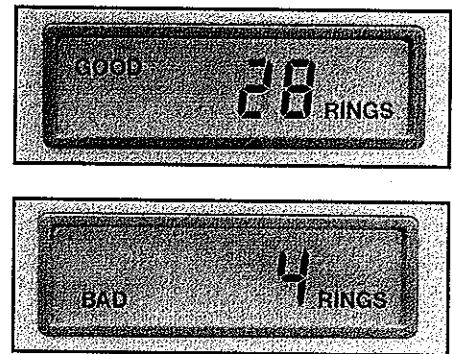

Fig. 29 Good yokes and transformers will ring greater than 10 (top), while a bad component will ring less than 10 (bottom).

Connecting the Test Lead to the coil places a capacitor in parallel with the coil. A pulse is applied to the cap/coil combination and the CM2125 automatically ranges the capacitor value to produce the highest number of "rings." The DIGITAL DISPLAY Readout shows the number of times the coil rings before it dampens out. A reading of "10" or more is "GOOD" and means that the coil does not contain a shorted turn. A "BAD" reading, less than 10 rings, indicates a shorted turn. The CM2125 provide two different Ringer Test positions that match the different types of coils found in monitors. Refer to the APPLICATIONS section for more details on ringing yokes and transformers.

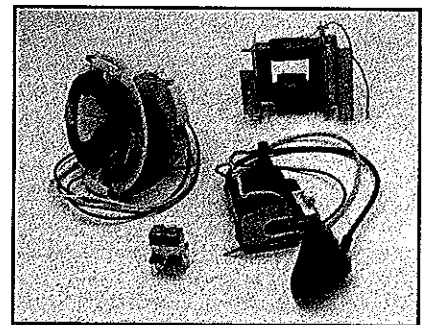

Fig. 30 Use the Ringer Test to locate shorted turns in switching transformers, yokes, flybacks and IHVTs.

Switching Xformers - Use this Ringer Test position to test the transformers used in switching power supplies. These transformers typically have a low "Q" than yokes and flybacks and need to be tested at a different level. The transformer needs to be removed from the circuit to make the Ringing test.

Yokes & Flybacks - Use this Ringer Test position for testing deflection yokes, flyback transformers, and the flyback portion of IHVTs. Refer to the APPLICATIONS section for special details on ringing flybacks and yokes.

Ringer Fuse - The Ringer Test function is protected from externally applied voltage by a 1 amp, 250 volt Slo-Blo fuse, type 3AG. The fuse holder is on the rear panel of the unit. If the fuse blows, the Ringer Test will read "0 RINGS" on every coil you test.

To replace the Ringer fuse:

1. Press to release the snap-in fuse holder.
2. Pull the holder and the fuse out of the fuse holder base.
3. Replace the fuse with another of the same type and rating.
4. Insert the holder and fuse into the fuse holder base and snap it back into place.

CAUTION

The wrong Ringer fuse may damage the CM2125. Replace only with type 0.5 Amp, 250 Volt, Fast-Blo Type 3AG.

To do the Ringer Test:

1. Connect the supplied DIRECT TEST LEAD to the RINGER TEST Jack.
2. Set the DIGITAL DISPLAY Switch to the component type to be tested.
3. Connect the direct Test Lead to the component.
4. Read the test result in the DIGITAL DISPLAY.

A reading of "10" or more indicates that the component does not have a shorted turn.

Notes: 1) IHVTs develop may develop failures other than shorted turns. 2) If the vertical winding of a yoke contains damping resistors, remove them first. See "Testing Yokes" on page 43. 3) Flyback Transformers may develop shorts between windings. See "Testing Flyback Transformers" on page 46.

DVM

The autoranged DVM portion of the DIGITAL DISPLAY section measures external DC and peak-to-peak voltages. Use the DIGITAL DISPLAY Switch to select the desired measurement. The DIGITAL DISPLAY Readout displays the voltage levels.

Use the supplied DVM TEST LEADS (39G264) to connect the external voltages to the PPV & DCV INPUT Jack. The input range limits are 2000 volts for both DCV and PPV, with the PPV frequency response extending from 30 Hz to 5 MHz. The measuring range of the DCV function is extended to 10 kV by the TP212 "10kV Transient Protector Probe" (optional), and to 50 kV with the (optional) HP200 "50kV High Voltage Probe."

WARNING

Over 1000 volts may be present at this terminal. Use extreme caution.

ATTENTION

Plus de 1000 volts peuvent être présent à cette terminaison. Faites très attention.

To measure external DCV and PPV:

1. Set the DIGITAL DISPLAY Switch to either "DCV" or "PPV".
2. Connect the "Banana" ends of the supplied DVM TEST LEADS to the PPV & DCV INPUT Jack.
3. Connect the probe ends of the supplied DVM TEST LEADS to the circuit test points.
4. Read the level in the DIGITAL DISPLAY Readout.
5. A flashing "888" display indicates the applied signal is greater than 1999 volts.

DRIVE SIGNAL MONITOR

The "Drive Signal" position of the DIGITAL DISPLAY Switch allows you to monitor the level of the internal Drive Signals. The DIGITAL DISPLAY Readout shows the signal level at the DRIVE OUTPUT Jack. The readings are accurate for all signals and ranges.

Drive Signals

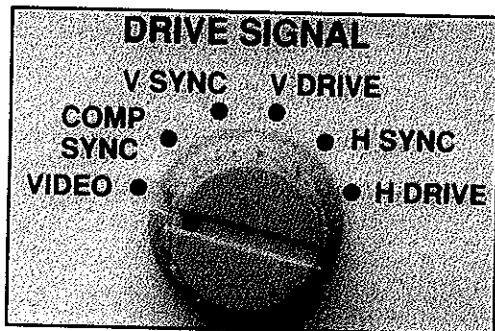

Fig. 31 - Use the drive signals to inject a known good signal into a defective stage in the monitor.

The Drive Signals provide a known good signal to substitute into the circuits to locate the defective stage. The Drive Signals are phase-locked to the RGB signals at the SYNC & VIDEO OUTPUT Jack to restore proper operation when substituting for the missing or wrong signal. Connect the monitor to the SYNC & VIDEO OUTPUT Jack and set the PARAMETERS and VIDEO FORMAT to match the monitor. Then, inject the substitute Drive Signals into the defective stages to restore normal operation. Specific information on troubleshooting using Signal Substitution and the Drive Signals is located in the APPLICATIONS section of this manual.

Use the supplied DIRECT TEST LEAD (39G221) to connect the DRIVE OUTPUT Jack to the circuit. The DRIVE OUTPUT Jack has a floating ground so you can use it independently of the other CM2125 Input or Outputs, and you can connect the "Ground" lead to points other than circuit ground.

Drive Signal Switch

The DRIVE SIGNAL Switch selects the signal available at the DRIVE OUTPUT Jack. The frequency of the Drive Signals match the RGB signals at the SYNC & VIDEO OUTPUT Jack and can be set with the PARAMETERS Buttons.

VIDEO - The "Video" Drive Signal provides the proper signal to inject into video stages, including the red, green and blue channels. The "Video" Drive Signal will produce the color of the channel it is injected into. Use the "Raster" VIDEO PATTERN with the "Video" Drive Signal for most troubleshooting applications.

The "Video" Drive Signal matches the green "Video Output" signal. Injecting using the "Color Bars" or "Staircase" video patterns into the red, green and blue channels will cause the color bars to appear in a different order.

COMP SYNC - This Drive Signal provides vertical and horizontal composite sync. Use it in monitors that contain sync separator stages. The frequencies match the SYNC & VIDEO OUTPUT signals. The "Interlace" VIDEO FORMAT Button turns interlace on and off.

V SYNC - The vertical sync Drive Signal provides the proper signal to inject into the vertical stages before the oscillator. The frequency matches the SYNC & VIDEO OUTPUT signal. The "Interlace" VIDEO FORMAT Button turns interlace on and off.

V DRIVE - The vertical drive Drive Signal closely matches the signal in the vertical output stages. Use it to inject into the vertical stages between the oscillator output and driver output.

H SYNC - The horizontal sync Drive Signal provides the proper signal to inject into the horizontal stages before the oscillator. The frequency matches the SYNC & VIDEO OUTPUT signal. This Drive Signal is also used to do the IHVT "Drive Test" explained in the APPLICATIONS section.

H DRIVE - The horizontal drive Drive Signal closely matches the signal in the horizontal output stages. Use it to inject into the horizontal stages between the oscillator output and the base of the output transistor.

Setting The Drive Level

The DRIVE RANGE and DRIVE LEVEL Controls adjust the peak-to-peak level of the signal at the DRIVE OUTPUT Jack. The DRIVE RANGE CONTROL provides a coarse adjustment of the output signal level. It sets the maximum output level at 3, 30, or 300VPP. The 3 & 30VPP ranges can drive a 100 ohm impedance before the output level drops, while the 300VPP range can drive a 10 kohm impedance.

Note: The "warning LED" will flash whenever the 300 VPP Drive Range is selected to warn you that the signal is sufficient to produce a shock.

The DRIVE LEVEL Control provides a variable signal level within the range set by the DRIVE RANGE Control. The signal level at the DRIVE OUTPUT Jack is shown in the DIGITAL DISPLAY Readout when the DIGITAL DISPLAY Switch is set to "Drive Signal." The DRIVE LEVEL Control also sets the polarity of the output signal. Turning the DRIVE LEVEL Control clockwise produces positive polarity signals, while turning the control counter-clockwise produces negative polarity signals.

To use the Drive Signals:

1. Set the DIGITAL DISPLAY Switch to "Drive Signal."
2. Set the DRIVE LEVEL Control to "0."
3. Select the desired Drive Signal.
4. Connect the DIRECT TEST LEAD to the DRIVE OUTPUT Jack and connect the test clips to the circuit test point and circuit ground.
5. Set the DRIVE RANGE CONTROL to the lowest range that includes the required signal level.
6. Adjust the DRIVE LEVEL Control to the desired level while reading the output level in the DIGITAL DISPLAY Readout.

COMPUTER AUTOMATED OPERATION

Introduction

The CM2125 Computer Monitor Analyzer can be used for computer controlled, automated testing. A simple computer program can be developed that automatically "sets up" the CM2125's front panel controls as well as collects test data.

The CM2125 can be used with either the IEEE-488 Bus and the Sencore IB72 accessory, or the RS232 Bus and the Sencore IB78 accessory. Both accessories connect to the INTERFACE ACCESSORY JACK on the rear of the CM2125.

Note: when using the CM2125 with the IB72 IEEE 488 Bus Interface, check if EPROM IC4 is version 2.0. If your IB72 has version 2.0, contact the Sencore Service Department for a replacement.

The CM2125 can be used as either a "talker" or "listener." When the CM2125 is in the "listener" mode, the computer has control of the front panel setup. The computer can automatically set the sync and pixel parameters, the video pattern, video format, digital display controls and the drive signal.

Note: the CM2125's drive signal level cannot be set by the computer.

When the CM2125 is in the "talker" mode, it sends information to the computer. Upon the correct command from the computer program, the CM2125 will send all of its front panel settings as well as ringer test readings, DC volts readings and peak-to-peak volts readings.

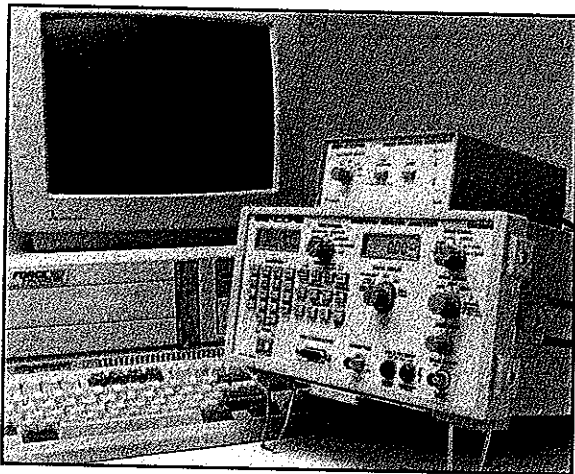

Fig. 32 - The CM2125 can be used for automatic testing by connecting an Interface Accessory and a computer.

CONNECTING THE CM2125 TO THE INTERFACE BUS

The CM2125 produces a specially formatted signal which must be translated by a Sencore Bus Interface Accessory. The interface accessory connects in series with the computer and the CM2125. A standard cable connects the computer and the interface accessory.

WARNING

Connect only the Sencore interface bus accessories to the INTERFACE ACCESSORY JACK on the rear of the CM2125. Do not connect other instruments or interface bus equipment to the CM2125 even if the connectors fit.

When the IEEE-488 bus system is used, the CM2125 must be assigned an address separate from the other products on the system. This enables the computer to select which instrument it talks or listens to (follow the individual instructions for the computer and interface accessory for connection and address requirements.)

WARNING

Do not apply power to the CM2125 or interface accessory until all connections have been made.

To connect the CM2125 to an automated test system:

1. Remove power from the CM2125, interface accessory, and the computer.
2. Set the slide switch on the rear of the IB72 IEEE-488 Bus Interface Accessory for the proper address assigned to the CM2125. No addressing is needed with the IB78.
3. Connect the interface accessory's male DIN connector to the INTERFACE ACCESSORY JACK located on the rear of the CM2125.
4. Connect the proper cable from the interface accessory to the computer.
5. Supply power to all units in the automated system, and verify all units have been turned on.

COMMAND DESCRIPTIONS

The same sequence of steps are required to use the CM2125 via the computer interface bus as are required for manual operation. The CM2125 uses an extensive series of commands to control the front panel setup. The entire command must be sent in order for the CM2125 to properly respond. Following is a listing of the control commands recognized by the CM2125:

The CM2125 As a Listener

HFQ XXX.X KHZ	set horizontal scan frequency (in KHz)
VFQ XXX.X HZ	set vertical scan frequency (in Hz)
HPX XXXX PIX	set horizontal pixel resolution
VPX XXXX PIX	set vertical pixel resolution
PAT RAS	select RASTER pattern
PAT DOT	select DOTS pattern
PAT CIR	select CIRCLE pattern
PAT BAR	select COLOR BARS pattern
PAT MLT	select STAIRCASE pattern
PAT STR	select WINDOWS pattern
PAT WIN	select MULTIBURST pattern
PAT TXT	select TEXT pattern
OUT DIG	set video output to digital
OUT ANA	set video output to analog
MOD INT	interlaced format mode
MOD NON	non-interlaced mode
VID+	set video to (+)
VID-	set video to (-)
HSY+	set horizontal sync to (+)
HSY-	set horizontal sync to (-)
VSY+	set vertical sync to (+)
VSY-	set vertical sync to (-)
RSY ON	place sync on red video
RSY OFF	take sync off of red video
GSY ON	place sync on green video
GSY OFF	take sync off of green video
BSY ON	place sync on blue video
BSY OFF	take sync off of blue video
RGN ON	turn red output on
RGN OFF	turn red output off
GGN ON	turn green output on
GGN OFF	turn green output off
BGN ON	turn blue output on
BGN OFF	turn blue output off
IGN ON	turn intensity output on
IGN OFF	turn intensity output off
STO XX	store setup in memory location XX
RCL XX	recall setup from memory location XX

DSP RYF	set the DIGITAL DISPLAY switch to RINGER TEST YOKES & FLYBACKS
DSP RSX	set the DIGITAL DISPLAY switch to RINGER TEST SWITCHING XFORMERS
DSP VDC	set the DIGITAL DISPLAY switch to DCV
DSP VPP	set the DIGITAL DISPLAY switch to PPV
DSP DRV	set the DIGITAL DISPLAY switch to DRIVE SIGNAL

DRV VID	set drive signal to VIDEO
DRV CMP	set drive signal to COMP SYNC
DRV VSY	set drive signal to V SYNC
DRV VDR	set drive signal to V DRIVE
DRV HSY	set drive signal to H SYNC
DRV HDR	set drive signal to H DRIVE

SPE	enable sync parameters change mode
SPD	disable sync parameters change mode

THS XXXX NS	set horizontal sync time
THF XXXX NS	set horizontal front porch time
THB XXXX NS	set horizontal back porch time

TVS XXXX US	set vertical sync time
TVF XXXX US	set vertical front porch time
TVB XXXX US	set vertical back porch time

CPO	resets the CM2125 to manual operation after a bus command has been received
-----	---

The CM2125 As a Talker

CPS ALL	returns all of the front panel settings and readings (18 lines of data)
CPS MET	returns digital display reading
CPS LCD	returns frequency/pixel display (4 lines of data)
CPS DTM	returns display timings
CPS DSP	returns digital display function
CPS DRV	returns which drive signal is being generated
CPS HFQ	returns horizontal sync frequency
CPS VFQ	returns vertical sync frequency
CPS HPX	returns horizontal pixel resolution
CPS VPX	returns vertical pixel resolution
CPS MEM	returns the memory location (if it has been stored)
CPS HSY	returns horizontal sync polarity
CPS VSY	returns vertical sync polarity
CPS OUT	returns digital or analog monitor type
CPS MOD	returns interlaced or non-interlaced
CPS RGN	returns if the R gun on or off
CPS GGN	returns if the G gun on or off
CPS BGN	returns if the B gun on or off
CPS RSY	returns if the R sync on or off
CPS GSY	returns if the G sync on or off
CPS BSY	returns if the B sync on or off

DATA RETURNED BY THE CM2125 IN THE TALKER MODE

All data returned from the CM2125 is in a standard data format. Each string of data is the same length and contains information in four data fields. Your computer program can keep the entire string of characters together, or it can separate the fields for calculations or processing.

Each data string is 25 characters long. The four data string fields are: (1) header, (2) data, (3) alpha and (4) end terminator. Each field has the same number of characters for any function, allowing you to use the same subroutines to process any returned data.

Following are the details for each field:

(1) **Header:** Characters 0-2 identify the nature of the data being sent to the computer.

(2) **Data:** Characters 3-19 contain the data.

(3) **Alpha:** Characters 20-22 are the units for data sent (e.g. KHZ) or an indicator for the panel setup (e.g. ON/OFF, NEG/POS).

(4) **End:** Terminator: Character 23 contains carriage return (ASCII decimal 13) and character 24 contains the line feed (ASCII decimal 10). Most computers respond to either, while others need both. A few computers may stop accepting data when the carriage return is sent, leaving the CM2125 hung up and waiting to send its last line feed character. If this happens, put an extra GET INPUT statement into your control program to let the CM2125 send its last character into an unused variable.

Header			Data																Alpha			End		
0	1	2	3	4	5	6	7	8	9	10	11	12	13	14	15	16	17	18	19	20	21	22	23	24
M	E	T	-	-	-	-	-	-	-	-	-	-	-	-	-	2	3	.	7	V	P	P	CR	LF
L	C	D	-	-	-	-	-	-	-	-	-	-	-	-	-	-	6	4	0	P	I	X	CR	LF
D	T	M	-	-	-	-	-	-	-	-	-	-	-	-	-	-	1	2	3	N	S		CR	LF
D	S	P	-	-	-	-	-	-	-	-	-	-	-	-	-	-	-	-	-	R	Y	F	CR	LF
D	R	V	-	-	-	-	-	-	-	-	-	-	-	-	-	-	-	-	-	V	I	D	CR	LF
H	F	Q	-	-	-	-	-	-	-	-	-	-	-	-	-	3	1	.	5	K	H	Z	CR	LF
V	F	Q	-	-	-	-	-	-	-	-	-	-	-	-	-	6	0	.	0	H	Z		CR	LF
H	P	X	-	-	-	-	-	-	-	-	-	-	-	-	-	-	-	-	-	0			CR	LF
V	P	X	-	-	-	-	-	-	-	-	-	-	-	-	-	1	0	2	4	P	I	X	CR	LF
M	E	M	-	-	-	-	-	-	-	-	-	-	-	-	-	-	7	6	8	P	I	X	CR	LF
H	S	Y	-	-	-	-	-	-	-	-	-	-	-	-	-	-	-	0	1	M	E	M	CR	LF
V	S	Y	-	-	-	-	-	-	-	-	-	-	-	-	-	-	-	-	-	N	E	G	CR	LF
O	U	T	-	-	-	-	-	-	-	-	-	-	-	-	-	-	-	-	-	P	O	S	CR	LF
M	O	D	-	-	-	-	-	-	-	-	-	-	-	-	-	-	-	-	-	D	I	G	CR	LF
R	G	N	-	-	-	-	-	-	-	-	-	-	-	-	-	-	-	-	-	N	O	N	CR	LF
G	G	N	-	-	-	-	-	-	-	-	-	-	-	-	-	-	-	-	-	O	N		CR	LF
B	G	N	-	-	-	-	-	-	-	-	-	-	-	-	-	-	-	-	-	O	F	F	CR	LF
R	S	Y	-	-	-	-	-	-	-	-	-	-	-	-	-	-	-	-	-	O	N		CR	LF
G	S	Y	-	-	-	-	-	-	-	-	-	-	-	-	-	-	-	-	-	O	F	F	CR	LF
B	S	Y	-	-	-	-	-	-	-	-	-	-	-	-	-	-	-	-	-	O	N		CR	LF
			-	-	-	-	-	-	-	-	-	-	-	-	-	-	-	-	-	0	F	F	CR	LF

CR = carriage return
LF = line feed

Fig. 33 - This is an example of the data format the CM2125 sends to the computer.

Error Codes

The CM2125 will display an error code on its right LCD display if it receives the wrong code or if a parameter exceeds its range limits.

CM2125 Interface Bus Error Codes

- | | |
|-----|---|
| E1 | Scan frequency beyond range of unit
(Example: trying to set HFQ 260). |
| E2 | Invalid bus command or bus command used incorrectly. |
| E3 | Pixel resolution is beyond range of unit
(Example: trying to set HPX 2049). |
| E4 | Function not allowed in selected format
(Example: trying to select the I line when the unit is in the analog mode). |
| E5 | Invalid memory store/recall location (Example:RCL 76). |
| E6 | Vertical timing entry too short
(Example: blanking time is less than 1/H). |
| E7 | Horizontal timing entry is too short.
(Example: sync width is less than 0.3 uSec or blanking time is less than 1.5 uSec). |
| E8 | Horizontal blanking time too long.
(Example: the blanking time is set longer than the total horizontal scan time or the defined number of pixels can't be fit in the resultant active video time). |
| E9 | Sync parameter change mode not enabled
(Example: program needs SPE code before sync timing changes can be made). |
| E10 | Vertical Pixel Count is forced to go below the range of the unit. This error only occurs from the front panel. |

Fig. 34 - CM2125 Error Codes

Setting Sync Pulse Timing Through The Interface Bus

The parameter setups for the most common monitors have been stored in the CM2125's memory locations 0-42. These setups contain the correct pixel, sync frequency parameters, and sync polarities for the standard monitor types. These setups also contain the correct sync timing parameters, including back porch time, front porch time, and blanking times for both the horizontal and vertical sync pulses. These sync pulse timing parameters determine the position of the raster on the display. If the parameters are incorrect, the raster may be shifted off of center on the display.

As the horizontal and vertical sync frequencies and horizontal and vertical pixels values are entered, the CM2125 automatically determines the monitor format and adjusts the sync timings accordingly. If the CM2125 doesn't recognize the format, it sets the parameters to a sync timing default (see the Specification sheet for the timing values). The monitor will display a pattern, but it may not be centered correctly on the screen.

There may be situations where you do a lot of testing on a monitor type that isn't recognized by the CM2125. If so, you can set the CM2125 to generate the signal timings you need. This is completed through the interface bus. Your special setups can be stored in memory locations 43-69, and can be recalled using the front panel "recall" button.

Example: Programming the CM2125's sync pulse timings through the interface bus. For our example we'll use a non-interlaced, analog monitor with the following specifications:

	Horizontal	Vertical
Frequency	65.2 KHz	61.6 Hz
Resolution	1024 Pixels	1024 Pixels
Front Porch	360 nsec	62 uSec
Sync	770 nsec	92 uSec
Back Porch	770 nsec	92 uSec
Polarity	+	+

Fig. 35 - An example of a computer monitor's timing parameters

Computer program that sets the above parameters:

Code	Description
100	SPE enables sync parameters change mode
110	HFQ 65.2 KHZ sets horizontal scan frequency
120	VFQ 61.6 HZ sets vertical scan frequency
130	HPX 1024 PIX sets horizontal pixel resolution
140	VPX 1024 PIX sets vertical pixel resolution
150	OUT ANA sets the video output to analog
160	HSY+ sets horizontal sync to (+)
170	VSY+ sets vertical sync to (+)
180	MOD NON non-interlaced mode
190	THS 770 NS sets horizontal sync time
200	THF 360 NS sets horizontal front porch time
210	THB 770 NS sets horizontal back porch time
220	TVS 92 US sets vertical sync time
230	TVF 62 US sets vertical front porch time
240	TVB 92 US sets vertical back porch time
250	STO 45 stores setup in memory location 45
260	SPD disables sync parameter change mode

When programming the sync timings through the interface bus, you need to make sure the pixel value doesn't exceed the time allotted by the programmed horizontal and vertical scanning frequencies or that the programmed setup doesn't exceed the bandwidth of the CM2125 (see Appendix H).

APPLICATIONS

INTRODUCTION

The Applications section will help you use the CM2125 to its fullest capabilities. It is divided into two main parts: 1) Understanding Monitors, and 2) Troubleshooting Monitors. The first part provides a basic overview of monitors and their operation. The second part covers troubleshooting applications using the CM2125.

You can use the APPLICATIONS section two ways. First, use it as a reference for how to do a specific test. For example, details on troubleshooting horizontal circuit problems are in the section entitled "Troubleshooting Horizontal Circuits." Use the Table of Contents to find the information you want.

Second, you can use the information in the APPLICATIONS section as a step-by-step troubleshooting guide. The material follows the

COMPUTER MONITOR FUNCTIONAL ANALYZING TROUBLESHOOTING GUIDE ("Trouble Tree") that accompanies this manual. The "Trouble Tree" will help you decide what tests and signal injections to do for a given symptom. It outlines a logical troubleshooting sequence that will lead you to the defective stage in the least time.

The APPLICATIONS section provides you with specific details and procedures for troubleshooting defective monitors. After you have become familiar with the test procedures, you will be able to troubleshoot following only the steps outlined by the "Trouble Tree." Begin your troubleshooting by selecting the "Trouble Tree" path that best fits the symptom you observe.

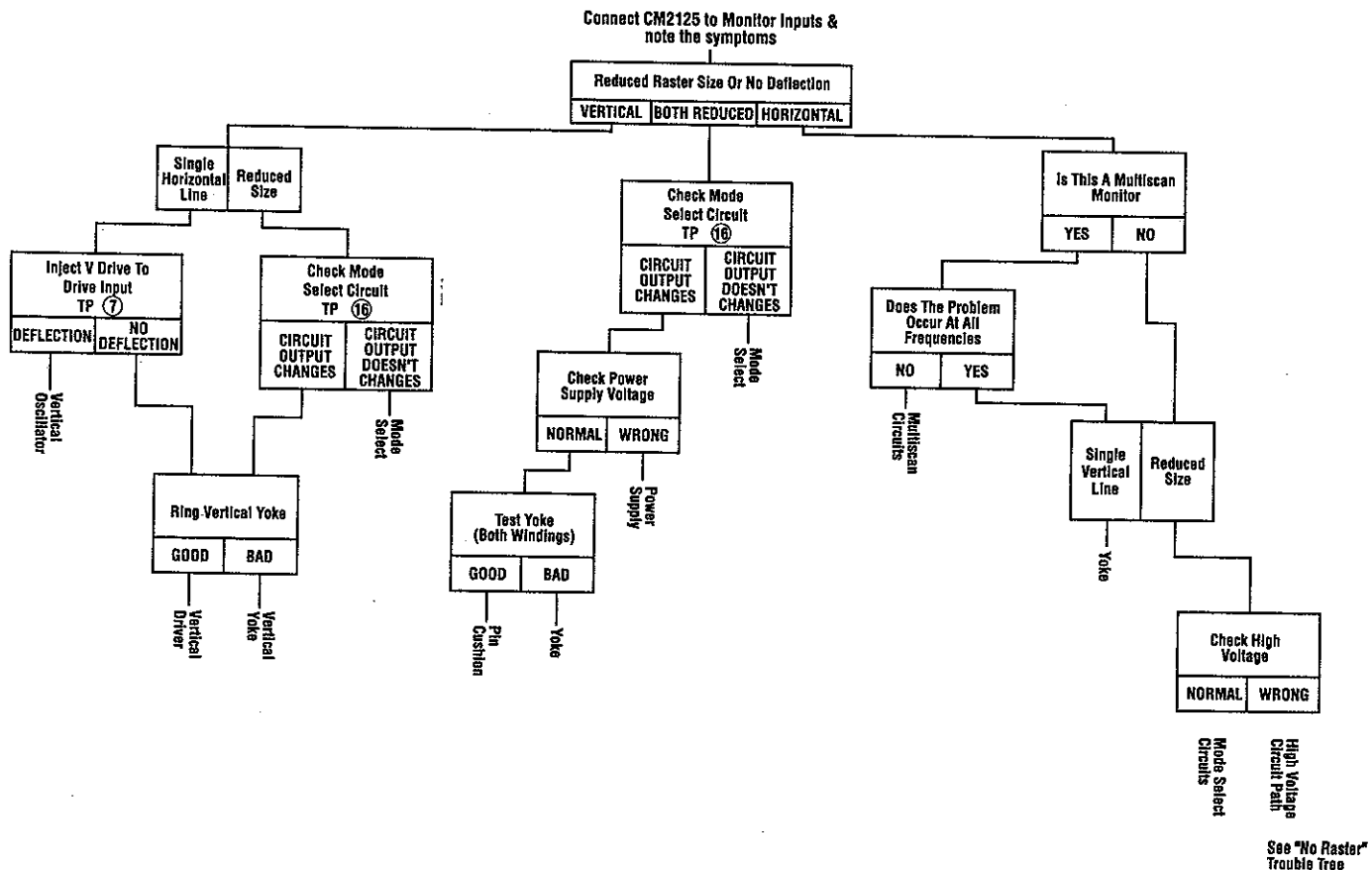

Fig. 36 - Select the "Trouble Tree" path that most closely matches the symptom of the computer monitor you are servicing.

Part 1 UNDERSTANDING MONITORS

Monitor Types

The CM2125 provides the signals necessary to service all types of monitors. These include RGB computer monitors, data display terminals, monochrome computer monitors, RGB video monitors and specialized display monitors requiring non-composite video inputs.

These monitors fall into two basic types: digital and analog. They can be either monochrome or color. The input signals to a digital monitor are a TTL logic level that is either high (greater than 2 volts) or low (less than 0.8 volts). Color digital monitors have red, green, blue, and usually an intensity input, and can display up to 64 colors using combinations of logic "1"s and "0"s on the input lines. Monochrome digital monitors may display up to 64 shades of gray (or green or amber depending on the phosphor) by also using combinations of logic levels on the inputs. Appendix F shows these level combinations.

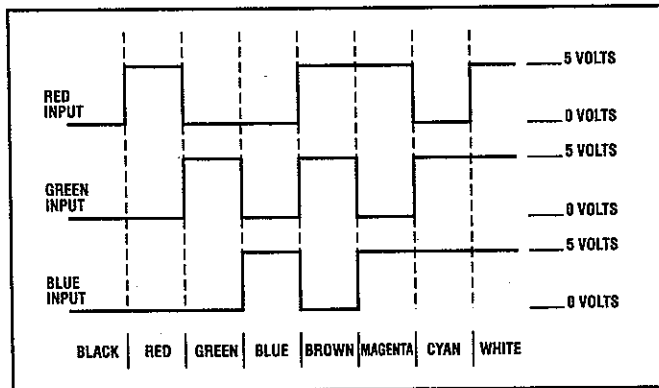

Fig. 37 - The signal input to digital monitors is either a logic low or a logic high.

Analog monitors can display an infinite number of colors or shades of gray. The video signal fed to an analog computer monitor is usually 0.7 VPP (black to white). The horizontal and vertical sync in analog monitors are usually digital levels.

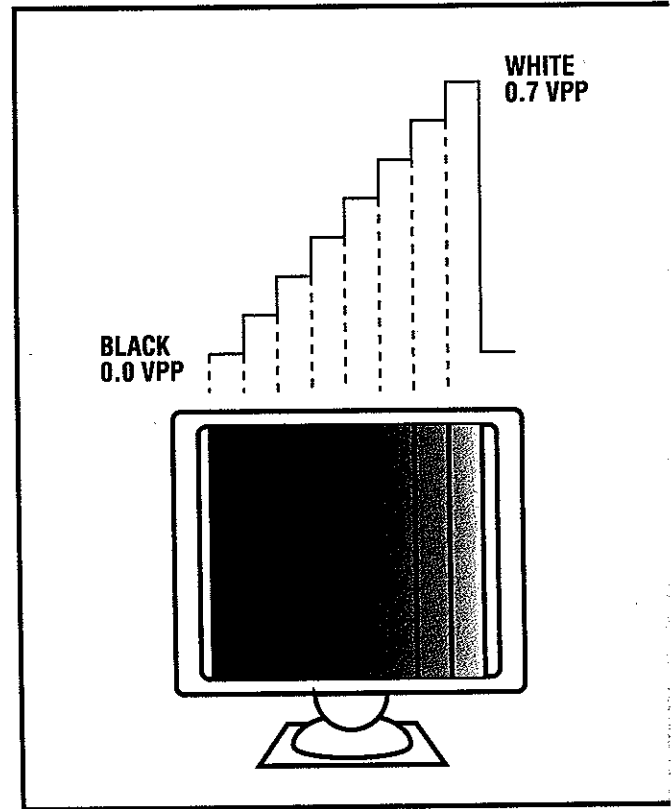

Fig. 38 - Analog monitors can display an infinite number of colors or gray shades.

Performance Capabilities

Four main parameters determine the performance capabilities of a monitor: horizontal frequency, horizontal pixels, vertical frequency and vertical pixels (lines). Here is a brief explanation of each:

Horizontal frequency is the number of times per second the electron beam travels horizontally across the CRT and back (horizontal scan). The inverse of horizontal frequency ($1/H \text{ FREQ}$) is the horizontal scan time.

Horizontal pixels are the number of dots or picture elements that can be displayed horizontally. A pixel is the smallest dot or picture element the monitor can produce.

Vertical frequency is the number of times per second the electron beam travels from the top of the CRT to the bottom and back (vertical scan). The inverse of vertical frequency ($1/V \text{ FREQ}$) is the vertical scan time.

Vertical pixels are the number of picture elements that are displayed vertically on the CRT. Vertical pixels can be compared to "lines" in television terminology.

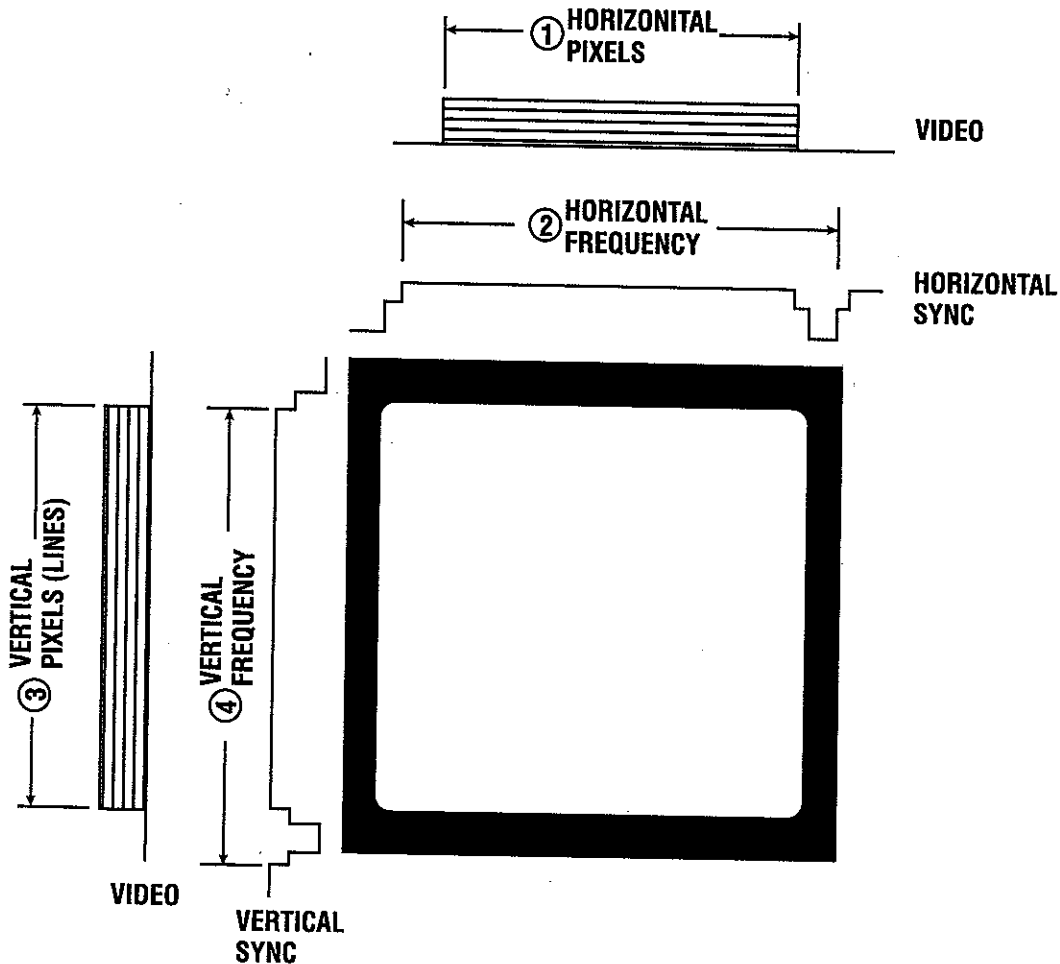

Fig. 39 - A computer monitor's performance capabilities can be defined by four parameters: (1) horizontal pixels, (2) horizontal frequency, (3) vertical pixels and (4) vertical frequency.

Increasing the horizontal frequency and the number of pixels displayed (displaying more pixels in less time) improves image clarity and resolution. High

resolution monitors can produce images with as much detail as 35MM film. For more information, refer to Appendix G, "Calculating A Monitor's Bandwidth."

FUNCTIONAL BLOCKS

Video Adapter Card

Monitors that are connected to computers receive their signal from a video graphics adapter card or circuitry located inside the computer. The adapter card generates the video and sync signals needed by the monitor. There are several different video graphics standards, such as color graphics adapter (CGA), enhanced graphics adapter (EGA), and video graphics adapter (VGA). Each standard produces different sync frequencies and pixel counts, and each video adapter card requires a compatible type monitor. Multiscan monitors work with any type of video graphics adapter card because they can sync to a wide range of frequencies. Appendix D gives a listing of the common graphic standards.

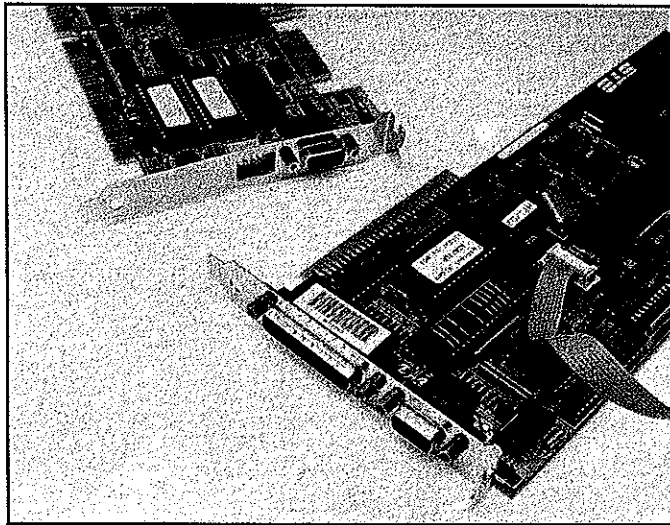

Fig. 40 - The video adaptor card is housed in the computer and is responsible for generating the video and sync signals.

Video Circuits

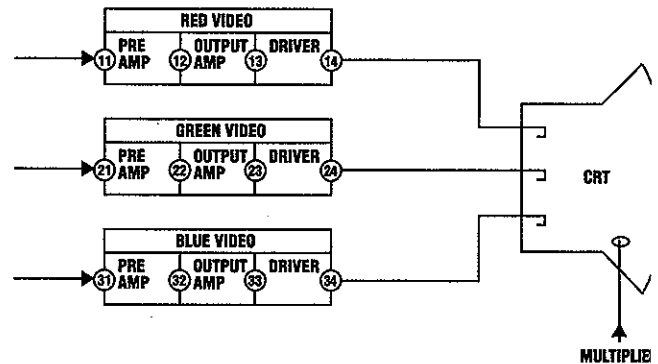

Fig. 41 - Video circuits block diagram.

The video circuits amplify the input signals to a level that is sufficient to drive the CRT. They also set the correct bias for the CRT and provide brightness and contrast control. Color monitors have 3 sets of identical amplifiers - one for each channel of the RGB signal. Each channel must function identically in order for the monitor to produce proper color.

Because of the fast scanning frequencies and high resolutions in monitors, the bandwidth of the video amplifiers is usually quite high. Bandwidths of 1 MHz or more are not uncommon. (Contrast this with the 4.2 MHz, or less, response of television receivers)

Sync Stages

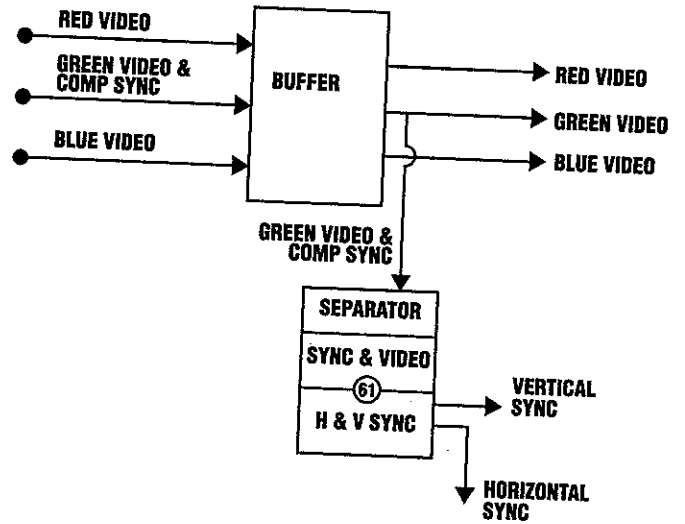
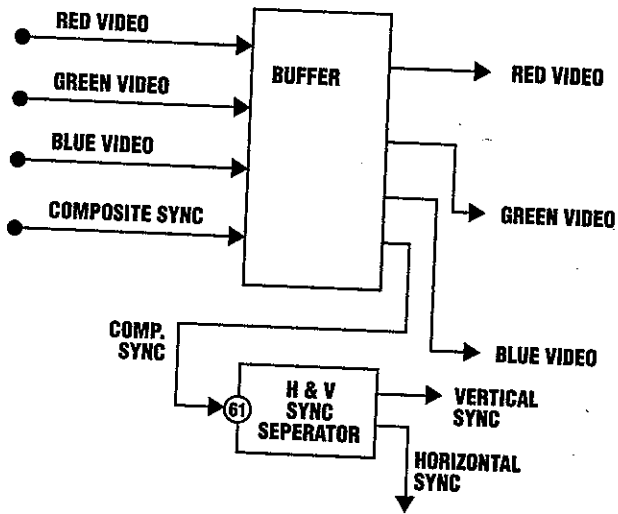

Fig. 33 - Some monitors have a composite sync input while others receive sync on one of the video lines.

Most monitors receive separate horizontal and vertical sync inputs that feed directly into the horizontal and vertical oscillators via a buffer. Some monitors use a composite sync input in which both the vertical and horizontal sync is fed in on the same pin. These monitors require a V&H sync separator stage to separate the sync signals before they are fed to the oscillators.

Other monitors, such as Apple Macintosh® monitors, use a composite sync signal on the green video input line. In these monitors, the sync must first be separated from the green video before the horizontal and vertical sync can be separated from one another.

Mode Select

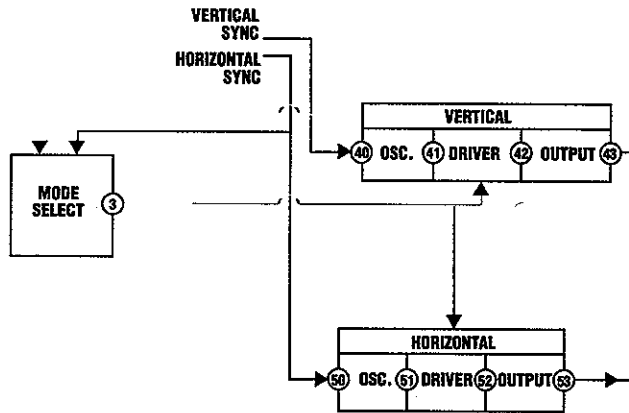

Fig. 43 - Mode select circuit block diagram.

Several monitor standards (PGC, MCGA, and VGA) have multiple graphics modes. The VGA standard, for example, has three modes as Fig 35 shows. VGA 1 and VGA 3 differ only in the number of pixels that are displayed. With everything else equal, the raster in VGA 1 (350 vertical pixels) would have less height than the raster in VGA 3 (480 vertical pixels), and the display would appear compressed.

Mode	Horizontal Resolution	Vertical Resolution (Pixels)	Horiz. Sync Polarity	Vert. Sync Polarity
(1) VGA	640	350	(+)	(-)
(2) VGA	720	400	(-)	(+)
(3) VGA	640	480	(-)	(-)

Fig. 44 - Standards for the three VGA modes.

A mode select circuit, used in some monitors, compensates for the compressed display that results from these different graphic modes. The mode select senses the input and tells the vertical driver to adjust the drive current to produce a full raster. The polarity of the horizontal and vertical sync pulses forms a code that tells the mode select circuit what graphics mode is applied. Figure 44 shows the polarity code. Test the mode circuits by changing the sync polarities and checking for proper raster height.

Vertical And Horizontal Circuits

The vertical and horizontal circuits each consist Oscillator, Driver, Output, and Yoke. The oscillate synchronized to the incoming video. It develops a signal that is amplified and converted to a current waveform by the driver. The output stage produces sufficient current to drive the deflection yoke. The yoke produces the magnetic field necessary to deflect the electron beam up and down and back and across the face of the CRT.

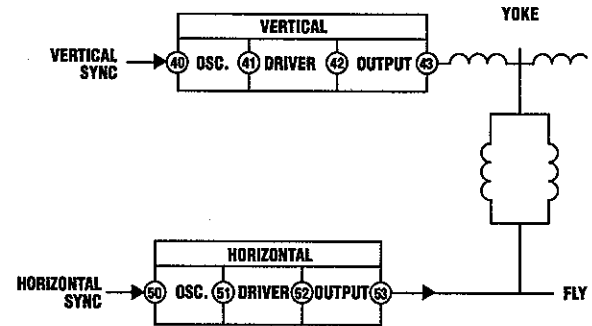

Fig. 45 - Vertical and horizontal circuits block diagram.

Problems in the oscillator result in no deflection, loss of sync. A problem in the driver, output or yoke results in no deflection, partial deflection, or linearity.

High Voltage and Power Supply Circuits

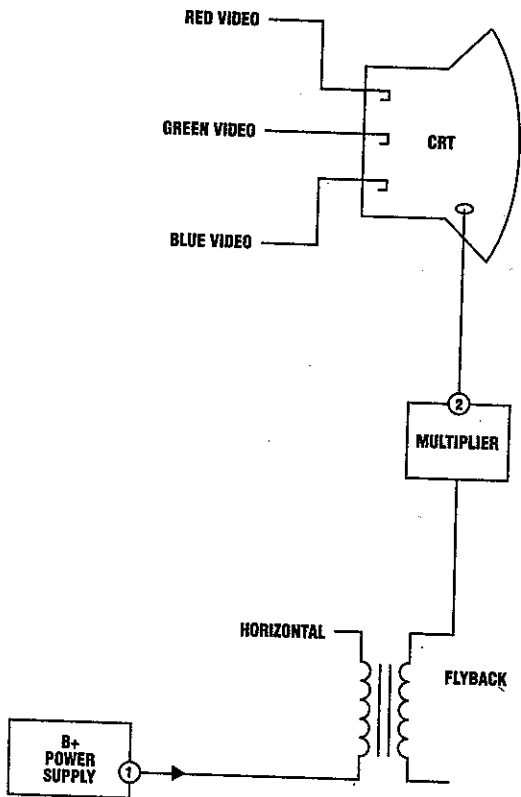

Fig. 46 - High voltage and power supply circuit block diagram.

The horizontal circuits have a second function besides providing deflection: they provide the drive signal to the flyback transformer that creates the focus and high voltage voltages, and other scan derived power supply voltages.

During normal operation, a large pulse is produced at the collector of the horizontal output transistor. The output connects to the primary of the flyback transformer so the pulses are induced into the flyback's secondary. The pulses are: 1) stepped up and rectified to produce the focus and high voltage, and 2) rectified to produce the DC voltages used to operate the monitor. Because these voltages depend on the pulse at the output transistor that occurs from horizontal scanning, they are called "scan derived".

Part 2 TROUBLESHOOTING MONITORS

GETTING STARTED

The CM2125 improves troubleshooting effectiveness through a technique called "Functional Analyzing". This method is made up of two parts: (1) signal injection and (2) signal tracing. Signal substitution lets you inject "known good" signals supplied by the CM2125, into the circuits. The low impedance of the Drive Signal output "swamps out" the signal that is

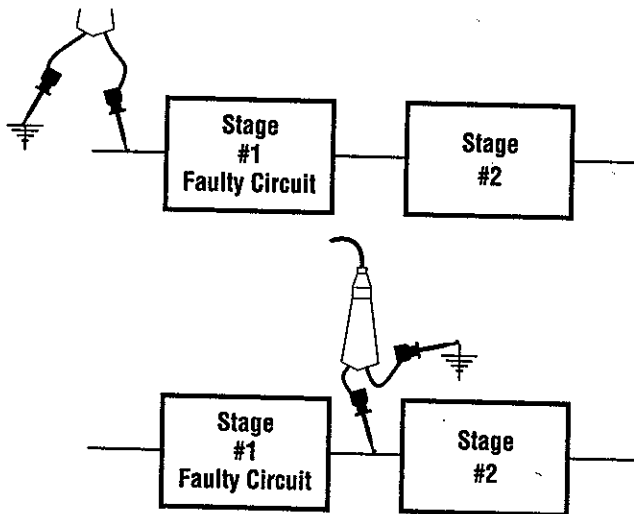

Fig. 47 - Use signal injection to narrow a problem down to a single stage.

present at the injection point and places a known good signal in its place. You watch the CRT to decide whether you are injecting before or after the defective stage. If the output remains bad, your injection is before the defective stage. If the output returns to normal, you can be confident that all the circuits between the injection point and the output are good.

Once you narrow the problem to a single stage, use signal tracing to find the faulty component. As you signal trace, compare the voltage levels, frequencies and waveshapes to those in the service literature.

Observe the following guidelines when using signal injection:

1. Match the Drive Signal level to that shown in the Service Literature. Too much signal may cause a bad stage to operate and lead to confusing results.
2. If no level is shown, never exceed the B+ voltage of the stage.

3. Match the Drive Signal polarity to the sign in the circuit.

The APPLICATIONS section of this manual follows the "Universal Monitor Block Diagrams" and "Monitor Functional Analyzing Troubleshooting Guide". Use the Universal Block Diagram and the "Trouble Trees" to identify the blocks that could cause the problem. Then locate that block in the service literature and begin your functional analyzing.

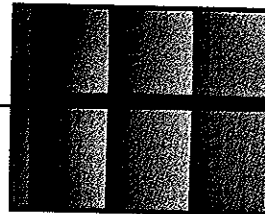

a. Injection recreates original symptom.

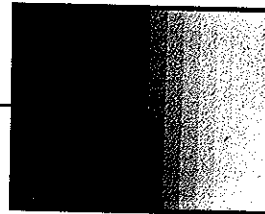

b. Injection returns a clear, locked-in picture.

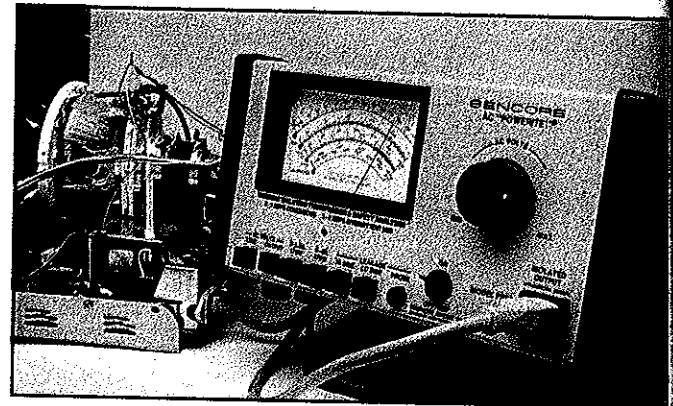

Fig. 48 - Always use an isolation supply before making any connections to the computer monitor chassis.

WARNING

Always use an isolation transformer when servicing any monitor chassis. Many monitors use a full-wave "hot chassis." Failure to isolate the chassis produces a dangerous shock hazard and may result in damage to the monitor or your test equipment.

Do not isolate your test instruments as this may create unsafe conditions.

USING THE PARAMETERS AND VIDEO FORMATS

The PARAMETERS and VIDEO FORMAT Buttons match the input signal requirements for all monitor types. Altering the Parameter and Format settings after the monitor is producing a display provides several important performance tests.

Troubleshooting Multiscan Monitors

Multiscan monitors lock to any applied horizontal and vertical sync frequency within a set range. A common problem in multiscan monitors is they will lock to a small frequency range, either horizontal or vertical, but are unable to lock over the entire range of input sync frequencies.

You can easily test and troubleshoot this problem with the CM2125. Simply enter the lowest vertical and horizontal sync frequencies, and the highest sync frequencies that the monitor should lock to. The monitor should produce a locked-in display at both frequency extremes. If the monitor locks to one but not to the other (either vertical or horizontal), troubleshoot either the automatic synchronizing circuits or the sweep circuits of the section that will not sync.

Example: Test if a CGA-VGA multiscan computer monitor can lock to both CGA and VGA video standards. The horizontal scanning frequency is 15.7 KHz for CGA and is 31.5 KHz for VGA.

1. Hook the CM2125 to the monitor using the CGA connector (connector #1)
2. Press
3. Hook the CM2125 to the monitor using the VGA connector (connector #4)
3. Press

What to expect: The computer monitor should have a locked-in display for both the CGA and VGA video standards. If the computer monitor syncs to one standard and not the other, you need to troubleshoot either the automatic synchronizing circuits or the horizontal or vertical sweep circuits (depending on which circuit has lost sync).

Testing Mode Select Circuits

The mode select circuit changes the horizontal and vertical drive current to produce a full-size raster for all operating modes. It detects the operating mode by sensing the polarity of the horizontal and vertical sync pulses. A faulty mode select circuit will cause the display to be too compressed or spread out.

Use the CM2125 to quickly determine if the computer monitor you are servicing automatically switches to each mode. Simply use the Memory function to recall the number of each operating mode and confirm that the monitor produces a full-height raster for each.

Example: Testing the mode select circuit on a VGA monitor.

1. Set the CM2125 to match the monitor type being serviced (see "Connecting To A Monitor" pages 10-19).
2. Press
(this is VGA mode 1).
3. Press
(this is VGA mode 2).
4. Press
(this is VGA mode 3).

What to expect: For each mode make sure the display is not distorted. If necessary, adjust the monitor's raster size and linearity controls. The computer monitor should produce a full display in each mode. If it does not, troubleshoot the mode select circuit or the vertical or horizontal driver stages.

Note: You can test the modes for standards that are not stored in the CM2125's memory by entering the Parameters directly.

Troubleshooting Video Circuits

The video circuits include all the stages from the input connectors to the CRT. These stages amplify the applied signal to sufficient level to drive the CRT. All the video channels (R, G & B) of a color monitor must have the same frequency response and gain. The video stages in a monochrome monitor must be linear between black and white. Use the VIDEO PATTERNS to check for proper video circuit operation. The patterns are explained in the OPERATIONS section of this manual.

normal B&W picture. Color RGB monitors have separate video stages for each color channel. Therefore, when you inject the CM2125 "Video" DRIVE SIGNAL you will return only red, or green, or blue, depending upon which channel you inject into.

A second difference is that the RGB signals are identical on B&W patterns, but different on color patterns. The CM2125's "Video" Drive Signal matches the green video channel. If you select the "Color Bars" Video Pattern and inject the "Video" Drive Signal into the red channel, you will see red bars at the location on the screen where the green

PROBLEM	SYMPTOMS	CM2125 VIDEO PATTERN USED TO TEST THIS
PURITY	SPLOTCHES OF COLOR IN WHITE OBJECTS	WHITE RASTER R, G, B TO "ON"
CONVERGENCE	STRAIGHT LINES SHOW COLOR SHADOWS	CIRCLE OR DOTS
COLOR	WRONG COLOR(S) OR MISSING COLOR(S)	COLOR BARS
LINEARITY	INCORRECT PICTURE HEIGHT AND WIDTH	CIRCLE
GRAY SCALE TRACKING (ANALOG ONLY)	RED, GREEN OR BLUE TINT IN A GRAY SCALE DISPLAY	STAIRCASE
RESOLUTION	LOSS OF DETAIL, FUZZY GRAPHICS, LINES BLEEDING TOGETHER	MULTIBURST OR TEXT
HIGH VOLTAGE REGULATION	JUMPY DISPLAY, BLOOMING, VARIATIONS IN BRIGHTNESS	RASTER (SWITCH BETWEEN "+" & "-" VIDEO) OR WINDOWS

Table 2 The video patterns test the performance of the computer monitor.

Video circuit problems include a complete loss of video, missing colors, weak video and poor frequency response. Most video problems can be effectively isolated using signal substitution. Signal substitution lets you inject a "known good" video signal into the video circuits from the first preamplifier to the CRT drivers.

Injecting into the video stages of RGB color monitors is similar to injecting into the video luminance stages of a color television receiver. However, there are two important differences. First, the video luminance stages in a television receiver affect all three CRT guns simultaneously so signal injection restores a

bars should be (if the red channel works from your injection point forward). Likewise, injecting into the blue channel produces blue bars at the location of the green bars. Note that while the colors are displaced, injecting the Drive Signal returns the missing output to the CRT.

To simplify interpretation, use the "Raster" pattern for most video troubleshooting applications. Inject the "Video" Drive Signal. If the missing output color returns, you are injecting after the defective stage.

Example: Injecting the VIDEO drive signal into the red, green and blue video output amplifiers.

1. Set the CM2125 to match the monitor type being serviced (see "Connecting To A Monitor" pages 10-19).
2. Connect the DIRECT TEST LEAD to the DRIVE OUTPUT Jack.
3. Set the VIDEO PATTERN Switch to "Raster."

4. Set the DIGITAL DISPLAY Switch to "Drive Signal."
5. Set the DRIVE SIGNAL Switch to "Video."
6. Select the DRIVE RANGE that is closest to the signal level in the circuit.
7. Connect the DIRECT TEST LEAD to test points (12), (22) or (32).
8. Adjust the DRIVE LEVEL Control to match the signal level found in the circuit.

Note: If the "R, G, & B" VIDEO OUTPUT lines are activated, substituting for the missing output will produce a white raster. You may prefer to turn off the VIDEO OUTPUT lines so that the raster is blank until you inject the missing output.

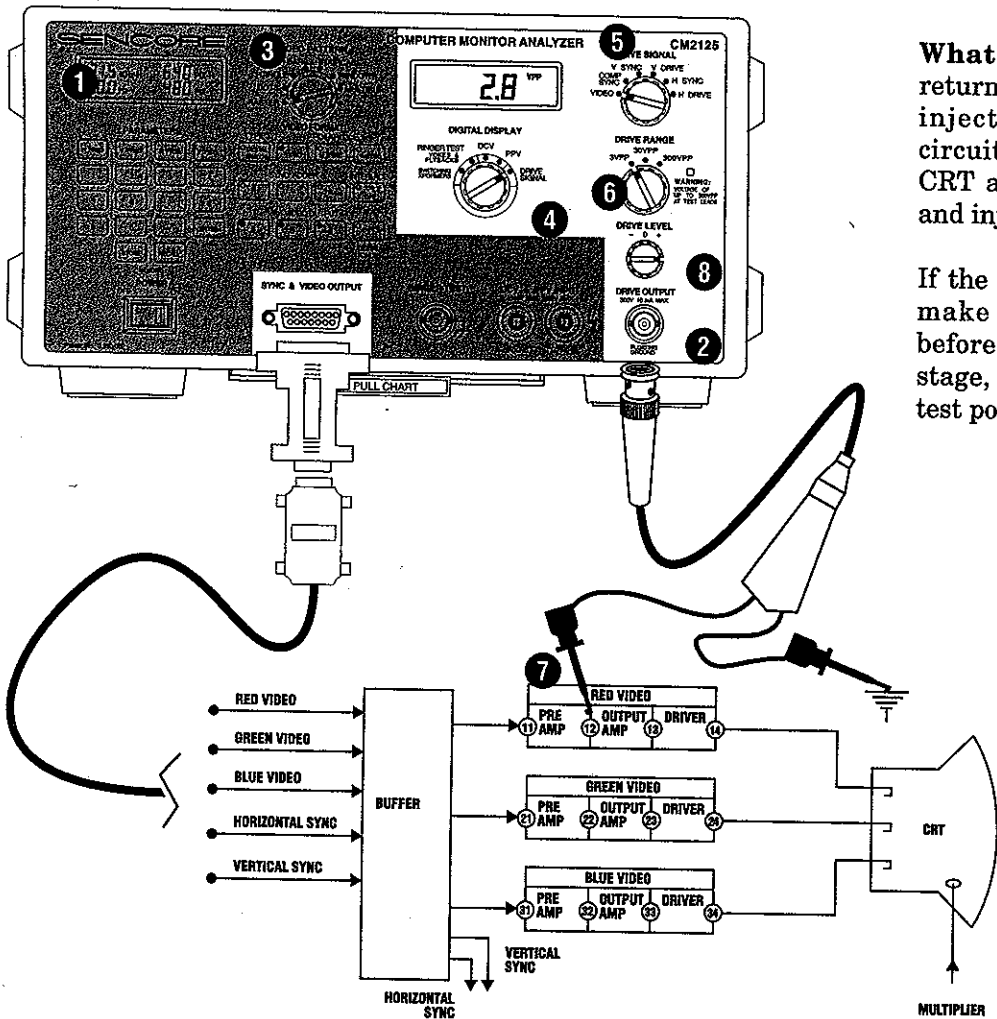

What to expect: If the missing color returns or the output improves, you are injecting after the problem and the circuits from the injection point to the CRT are working. Move back one stage and inject at test points (11), (21) or (31).

If the same problem is created after you make the injection, you are injecting before the problem. Move forward one stage, to the driver inputs and inject at test points (13), (23) and (33).

Fig. 49 - Video circuit troubleshooting.

TROUBLESHOOTING SYNC SEPARATOR PROBLEMS

Sync signals are fed to monitors by one of three methods: 1) separate V and H sync inputs; 2) V&H composite sync input; and 3) V&H composite sync on a video line (usually green). Monitors that receive a composite sync input have a Composite Sync Separator. Monitors that use "sync on video" have a Video/Sync Separator ahead of the Composite Sync Separator.

Sync separator problems cause a loss of either vertical or horizontal sync, or both. Some symptoms may lead you to suspect the problem is the horizontal or vertical circuits. Use the CM2125's "Comp Sync" Drive Signal to isolate sync problems in V&H or Video Sync Separator stages.

Example: Troubleshooting a sync separator problem on a "sync on video" computer monitor.

1. Set the CM2125 to match the monitor type being serviced (see "Connecting To A Monitor" pages 10-19).
2. Connect the DIRECT TEST LEAD to the DRIVE OUTPUT Jack.
3. Set the VIDEO PATTERN Switch to "Color Bars."
4. Set the DIGITAL DISPLAY Switch to "Drive Signal."
5. Set the DRIVE SIGNAL Switch to "Comp Sync."
6. Select the DRIVE RANGE that is closest to the signal level in the circuit.
7. Connect the DIRECT TEST LEAD to test point ①.
8. Adjust the DRIVE LEVEL Control to match the signal level found in the circuit.

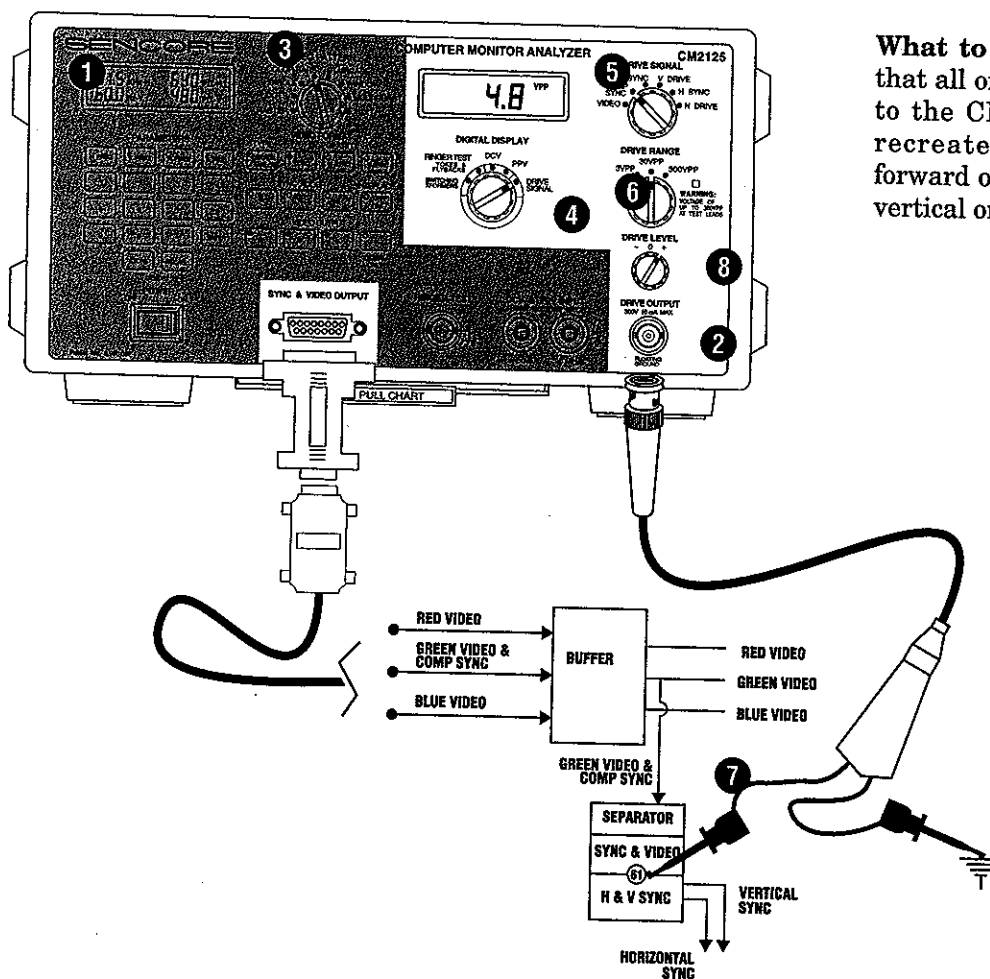

What to expect: A locked in display proves that all of the circuits from the injection point to the CRT are good. If the injection is recreated the original symptom, move forward one stage and troubleshoot either the vertical or horizontal sweep circuits.

Fig. 50 - Sync separator troubleshooting.

TROUBLESHOOTING VERTICAL CIRCUITS

Troubleshooting Vertical Sync Problems

The vertical sync pulses control the timing of the vertical oscillator and sweep circuits. Sync pulses that are too low in amplitude, the wrong frequency, or are missing will cause the monitor to lose vertical hold.

Some monitors do not have a vertical oscillator. Instead, they depend entirely upon the incoming vertical sync signal to drive the deflection stages. These monitors will lose vertical deflection if the sync amplitude is too low or is missing, resulting in a single horizontal line on the screen.

Use the "V Sync" Drive Signal to inject a good signal at the input to the oscillator stage. This will determine whether the problem is in the vertical oscillator or sync line, or in the vertical sweep circuits.

Example: Troubleshooting a vertical sync problem.

Note: If the monitor operates correctly when connected to the CM2125's SYNC & VIDEO OUTPUT Jack without injecting a Drive Signal, the signal supplied by the video adapter circuits in the computer are generating vertical sync pulses at the wrong frequency or amplitude.

1. Set the CM2125 to match the monitor type being serviced (see "Connecting To A Monitor" page 10-19).
2. Connect the DIRECT TEST LEAD to the DRIVE OUTPUT Jack.
3. Set the VIDEO PATTERN Switch to "Color Bars"
4. Set the DIGITAL DISPLAY Switch to "Drive Signal."
5. Set the DRIVE SIGNAL control to "V Sync."
6. Select the DRIVE RANGE that is closest to the signal level in the circuit.
7. Connect the DIRECT TEST LEAD to test point (40).
8. Adjust the DRIVE LEVEL Control to match

What to expect: If the monitor regains vertical hold and gives complete vertical deflection, the oscillator and the following stages work properly. Troubleshoot the vertical sync path. If the monitor displays the same symptoms with the vertical sync signal applied, the problem is in the oscillator, driver or output stages.

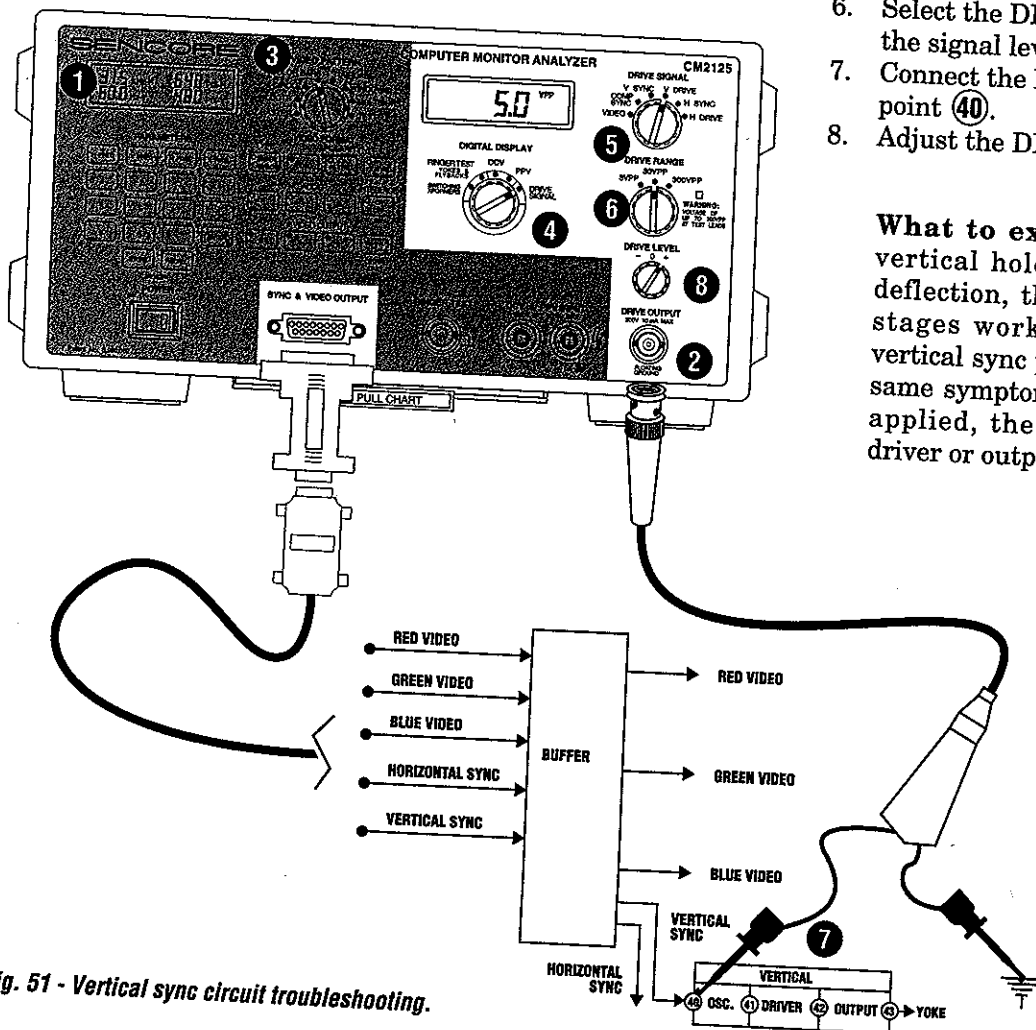

Fig. 51 - Vertical sync circuit troubleshooting.

Troubleshooting Vertical Drive Circuits

The vertical Driver and Output stages amplify the oscillator signal and provide the current drive needed for the vertical deflection yokes. A defective Driver, Output or yoke can cause loss of deflection, reduced height, or vertical non-linearity.

Use the CM2125's "V Drive" Drive Signal to isolate vertical drive circuit problems. Before you inject the Drive Signal, however, use the DVM Function to confirm the proper bias on the output components. The vertical stages are usually DC coupled to achieve good linearity. A wrong DC voltage affects all the components in the Oscillator, Driver and Output stages.

Injecting into the vertical stages won't always restore perfect vertical deflection. This is because most of the signals are uniquely shaped by feedback loops and waveshaping circuits. The Vertical Drive signal can't

exactly match all the different waveshapes, but it will produce a change in deflection when injected into good stages. If driving the Driver or Output stage doesn't return sweep, either fully or partially, a component after your injection is bad.

Note: The V DRIVE signal is not designed to drive the vertical yoke.

Example: Troubleshooting a vertical deflection problem.

1. Set the CM2125 to match the monitor type being serviced (see "Connecting To A Monitor" page 10-19).
2. Connect the DIRECT TEST LEAD to the DRIVE OUTPUT Jack.
3. Set the VIDEO PATTERN Switch to "Color Bars."
4. Set the DIGITAL DISPLAY Switch to "Drive Signal."
5. Set the DRIVE SIGNAL Switch to "V Drive."
6. Select the DRIVE RANGE that is closest to the signal level in the circuit.
7. Connect the DIRECT TEST LEAD to test point (41).
8. Adjust the DRIVE LEVEL Control to match the signal level found in the circuit.

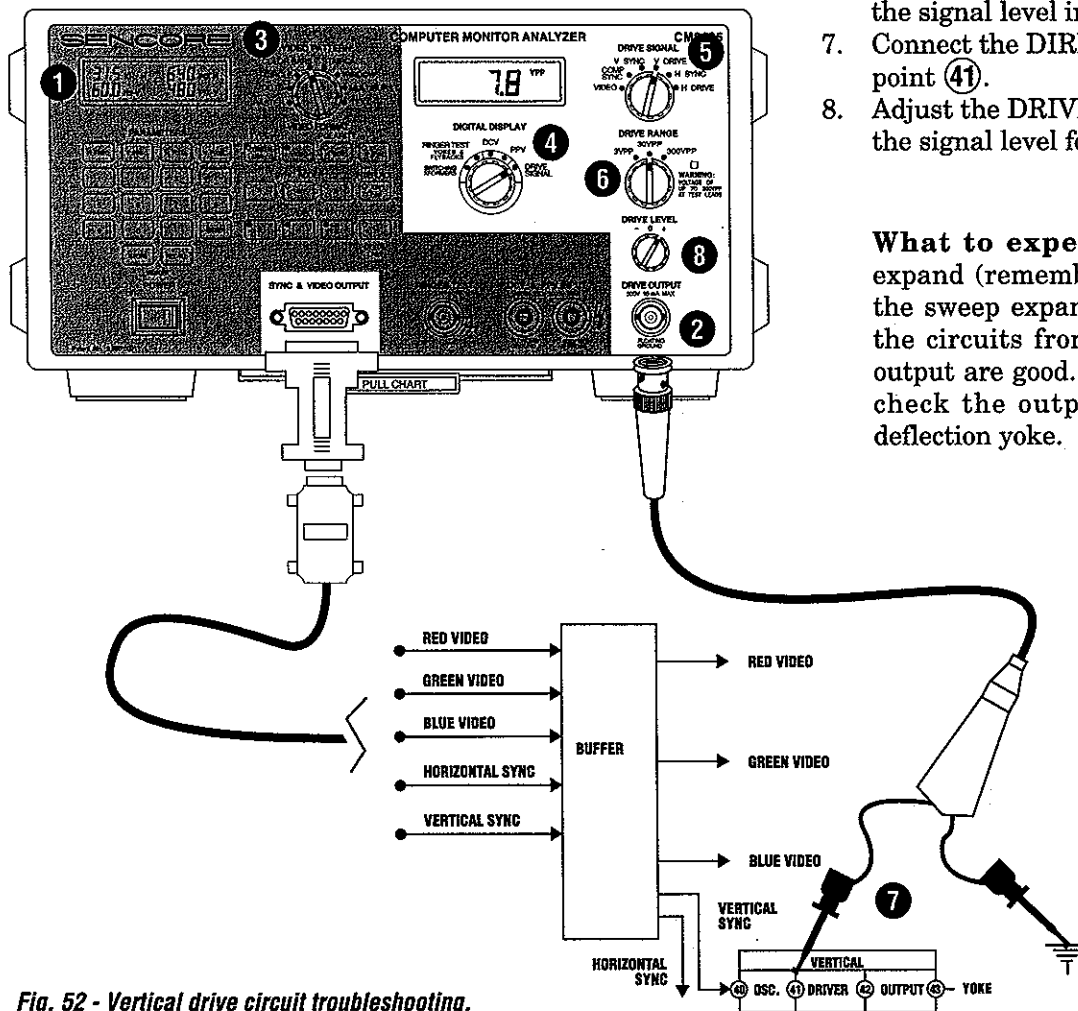

Fig. 52 - Vertical drive circuit troubleshooting.

What to expect: Look for the sweep to expand (remember it may not be linear). If the sweep expands, either partially or fully, the circuits from the injection point to the output are good. If the sweep doesn't expand, check the output transistors or ring the deflection yoke.

Testing Deflection Yokes

The changing current through the windings of the deflection yoke produces a magnetic field that scans the electron beam across the face of the CRT. Yokes often develop shorted or open windings. An open or shorted winding may cause reduced vertical or horizontal raster size, or a complete loss of deflection.

The Ringer Test will find a defective yoke, even if it has a single shorted turn. A good coil will ring 10 or more times. Shorted or open coils will ring less than 10.

Follow these tips when testing yokes:

1. Deflection yokes have two sets of horizontal windings and two sets of vertical windings. Always test each winding individually because a short in one winding may not couple to the other.
2. Test the yoke while it is mounted on the CRT. Some failures are caused by the pressure of the mounting. Removing the yoke may relieve the pressure and clear the short.

3. Always unhook the yoke from the circuit. Often this is done by simply disconnecting the yoke plug. At other times you may need to unsolder the wires between the output stages and the yoke.

4. The vertical windings are paralleled by damping resistors. If the resistors are mounted on the yoke (they may be hidden by the plastic terminal cover), they must be removed to test. Otherwise the windings will ring bad, even if they are good. The damping resistors may also be located on the chassis. If so, they are automatically unhooked when the yoke is disconnected.

5. The vertical windings are located on the sides of the yoke. The horizontal coils are located on the top and bottom of saddle-type yokes, and are the toroidal windings of toroid-type yokes.

6. Do not test the yoke on a metal surface. The metal may act like a shorted turn and cause the tests to show bad.

7. Some toroidal yokes have a metal band around their perimeter. The band makes the yoke ring as though it had a shorted vertical winding. Use 5 rings as the GOOD/BAD cutoff for the vertical windings in these yokes. Bad vertical windings will ring 0 or 1. Continue to use 10 rings for the horizontal windings.

Example: Ringing a deflection yoke.

1. Disconnect the yoke from the circuit, leaving it mounted on the CRT.
2. Disconnect the damping resistors if you are testing the vertical windings.
3. Set the DIGITAL DISPLAY Switch to RINGER TEST "Yokes & Flybacks."
4. Connect the DIRECT TEST LEADS to the RINGER TEST Jack.
5. Connect the DIRECT TEST LEADS to the yoke winding.
6. Read the test result in the DIGITAL DISPLAY Readout.

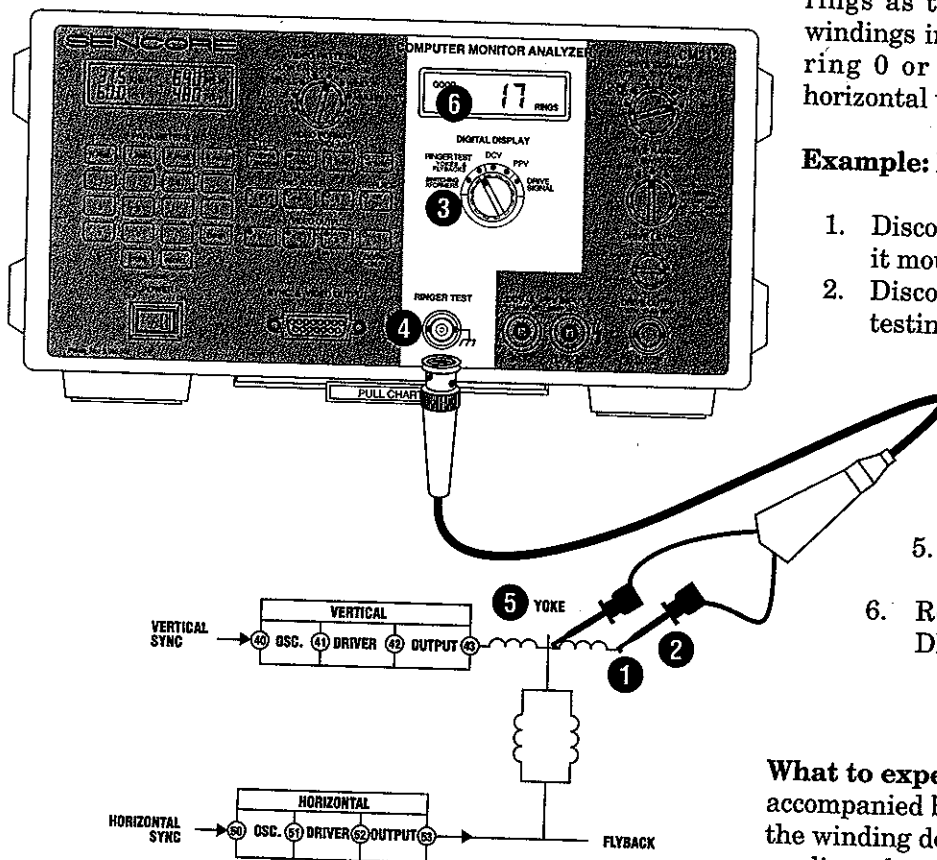

Fig. 53 - Ringing a deflection yoke.

What to expect: Readings of 10 rings or more are accompanied by a "Good" display and indicate that the winding does not have a shorted turn. "Bad" readings, less than 10 rings, indicate a shorted turn.

Testing Switching Transformers

Switching transformers are used in power supply circuits to step voltages up or down. They are much different from conventional power transformers in both appearance and operation. Power transformers usually operate at 60 Hz, and therefore contain a laminated iron core which is often visible. Because the iron core is low Q and absorbs all ringing energy, power transformers cannot be tested with the CM2125.

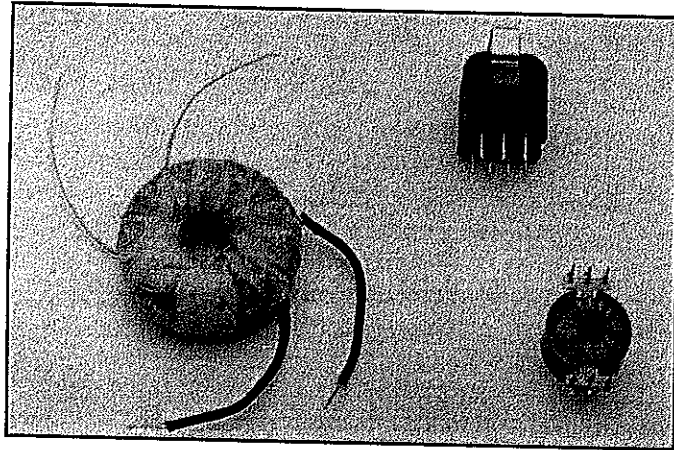

Fig. 54 - The toroid (left) and PC mount are two common types of switching transformers.

Switching transformers, on the other hand, are much smaller and lighter than power transformers. They are wound around a ferrite core which easily rings when good. Switching transformers operate at much lower currents and much higher frequencies than power transformers.

Example: Testing a switching transformer with the CM2125.

1. Remove the switching transformer from the circuit.
2. Set the DIGITAL DISPLAY Switch to RINGER TEST "Switching Transformers."
3. Connect the DIRECT TEST LEADS to the RINGER TEST Jack.
4. Connect the DIRECT TEST LEADS to the switching transformer.
5. Read the test result in the DIGITAL DISPLAY Readout.

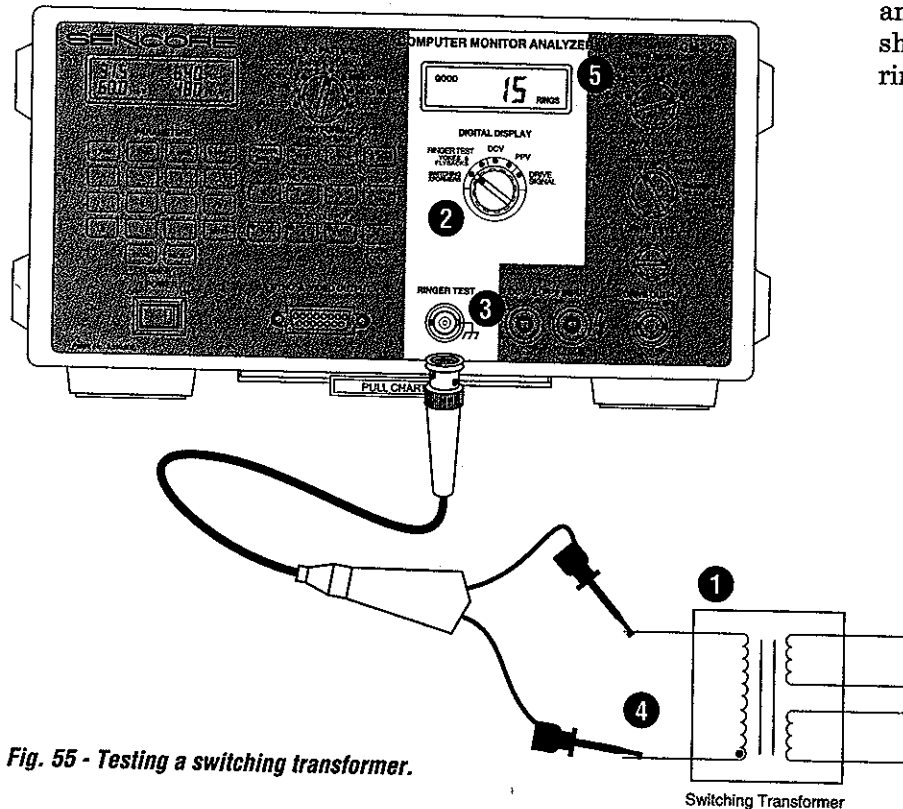

Fig. 55 - Testing a switching transformer.

What to expect: Readings of 10 rings or more are accompanied by a "Good" display and indicate that the winding does not have a shorted turn. "Bad" readings, less than 10 rings, indicate a shorted turn.

TROUBLESHOOTING HORIZONTAL CIRCUITS

Troubleshooting Horizontal Sync Problems

The horizontal sync pulses control the timing of the horizontal oscillator. Many monitors receive horizontal sync directly. Other monitors have a composite sync, or "sync on video" input and require the use of sync separators. Sync pulses that are low in amplitude, the wrong frequency, or are missing cause the monitor to lose horizontal hold.

Some monitors do not have a horizontal oscillator. Instead, they use the incoming sync signal to drive the deflection stages. These monitors will not power up if the sync signal is too low in amplitude, or is missing. This is because they use a scan derived power supply in which the horizontal output stage supplies the operating voltages.

Use the "H Sync" Drive Signal to inject a good signal into the horizontal oscillator. This will determine whether the problem is in the stages before the oscillator, or in the sweep circuits.

Example: Troubleshooting a monitor with a horizontal hold problem.

1. Set the CM2125 to match the monitor type being serviced (see "Connecting To A Monitor" page 10-19).

Note: If the monitor operates correctly when connected to the CM2125 SYNC & VIDEO OUTPUT Jack without injecting a Drive Signal, the signal being supplied by the video adapter circuits in the computer is generating horizontal sync pulses at the wrong frequency or amplitude.

2. Connect the DIRECT TEST LEAD to the DRIVE OUTPUT Jack.
3. Set the VIDEO PATTERN Switch to "Color Bars."
4. Set the DIGITAL DISPLAY Switch to "Drive Signal."
5. Set the DRIVE SIGNAL control to "H Sync."
6. Select the DRIVE RANGE that is closest to the signal level in the circuit.
7. Connect the DIRECT TEST LEAD to test point (50).
8. Adjust the DRIVE LEVEL Control to match the signal level found in the circuit.

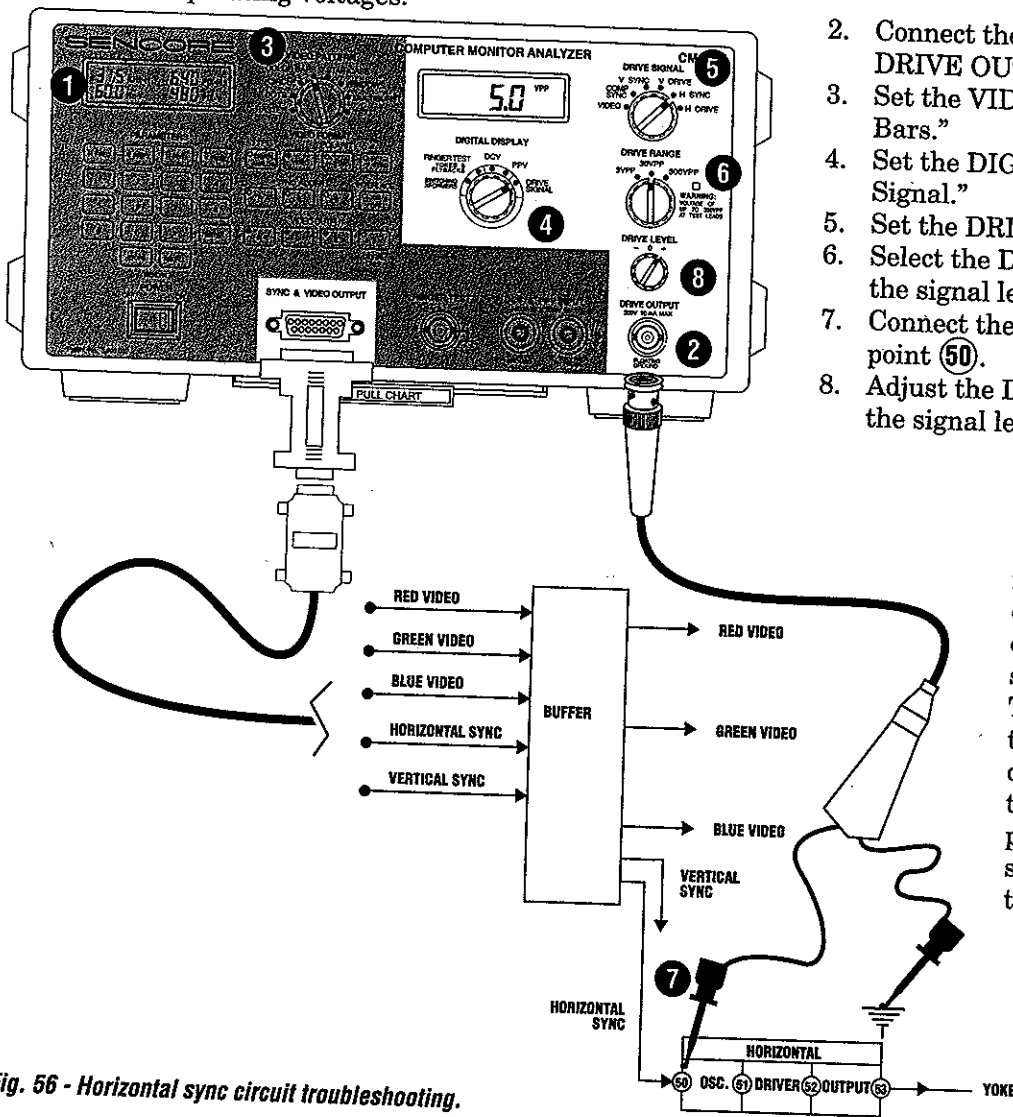

What to expect: If the monitor regains horizontal hold and gives a full horizontal deflection, or if a dead monitor returns to operation, the Driver and Output stages work properly. Troubleshoot the oscillator and the sync path. If the monitor displays the same symptoms with the Drive Signal applied, the problem is in the Driver or output stages. Use the "H Drive" signal to inject into the output stages.

Fig. 56 - Horizontal sync circuit troubleshooting.

Troubleshooting Horizontal Output & High Voltage Problems

The horizontal output circuits are the heart of the monitor. The quickly-changing current in the output stages provides a practical, efficient source of operating voltages for use throughout the monitor. The horizontal output circuits are directly responsible for: 1) horizontal scanning; 2) CRT high voltage; 3) CRT focus voltage; 4) "Scan derived" low voltage supplies; and 5) feedback gating signals.

Components that make this happen are the horizontal output transistor, B+ supply, flyback transformer, high voltage multiplier and the startup and safety shutdown circuits. The horizontal yoke is not responsible for generating high voltage, but it is tied directly into the output circuits and may affect the output voltages if it is defective.

Failures in the horizontal output stages are common because the components are subjected to constant high current and high voltage stress. Without good troubleshooting procedures and test equipment, horizontal output problems can be difficult to isolate because the components interact so closely and the failure of any components often creates the same symptom: a dead monitor.

Several features of the CM2125 help simplify troubleshooting horizontal output problems. These are the Ringer Test, the Horizontal Drive Signal, and the DCV and PPV meter.

Testing Flyback Transformers

A flyback transformer can develop one of three common failures. Following is a brief explanation of each and the troubleshooting procedure to locate the failure.

First, a winding may develop an open or shorted turn. An open winding is usually easy to detect. Measure the DC or PPV output with the CM2125's DVM if the chassis is operational, or check for continuity with an ohmmeter. A shorted turn, however, can only be detected using the CM2125's Ringer Test. The change in resistance that it causes is too small to be detected with an ohmmeter.

A second failure is common only to flybacks that contain a high voltage multiplier. These flybacks are called integrated high voltage transformers, or IHVTs. If the multiplier portion of an IHVT fails, the high voltage and/or focus voltage will be low or missing. Test for this failure by driving the IHVT with the Horizontal Drive Signal and measuring the resulting output.

A third failure occurs when a flyback transformer develops a leakage path between two windings, or between a winding and the transformer's core or mounting bracket. A high resistance leakage path often pulls down the B+ supply, even if the horizontal output transistor is disconnected from the circuit. Usually the leakage path goes unnoticed until operating voltages are applied to the flyback. Use a "Hi Pot" test, such as the Sencore "Z-Meter" Leakage test, to isolate leakage between windings.

Note: Leakage between windings is different than a shorted turn. The Hi Pot test will find leakage between windings, but not a shorted turn. The Ringer test will find the more common shorted turn, but will not find leakage or shorts between windings.

Example: Ringing a flyback transformer for a shorted or opened winding.

1. Remove AC power from the monitor.
2. Set the DIGITAL DISPLAY Switch to RINGER TEST "Yoke & Flybacks."
3. Connect the DIRECT TEST LEAD to the CM2125 RINGER TEST Jack.
4. Connect the DIRECT TEST LEAD to the flyback's primary winding. (*The primary winding connects between the B+ supply and the collector of the horizontal output transistor*).
5. Read the test results in the DIGITAL DISPLAY Readout.

What to expect: A "Good" reading of "10" rings or more means that none of the windings in the flyback are shorted. You do not need to ring any other winding. A shorted turn in any other winding will cause the primary to ring bad.

A "Bad" reading, less than 10 rings, may be caused by a circuit connected to the flyback that is loading the Ringer test. Disconnect the most likely circuits in the following order: 1) Yoke; 2) CRT filament (unplug the CRT socket); 3) horizontal output transistor collector; 4) scan derived supplies. Retest the flyback after you disconnect each circuit. If the flyback now rings "good," it does not have a shorted winding.

If the flyback still tests bad after you've disconnected each of the above circuits, unsolder it and completely remove it from the circuit. If the flyback primary still rings less than 10, ring the rest of the windings. If one of the other windings rings above 10, the flyback is good. If not, the flyback is bad and must be replaced.

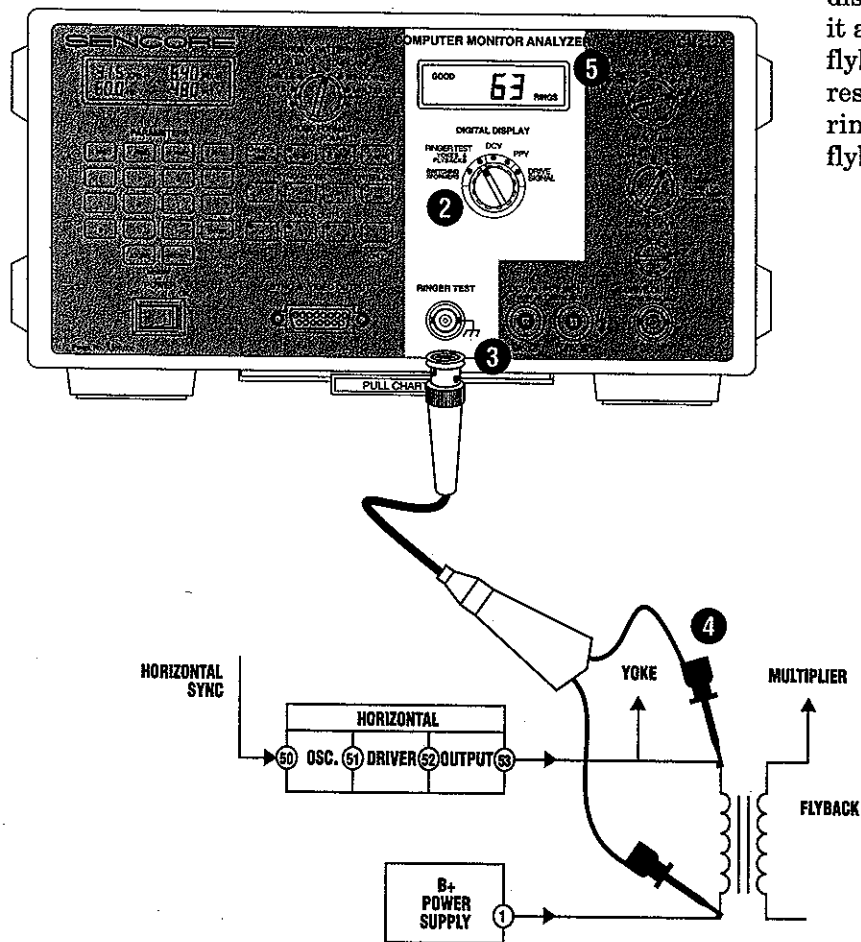

Fig. 57 - Ringing a flyback transformer.

Testing The Multiplier In An Integrated High Voltage Transformer (IHVT)

Example: Testing the multiplier section of an IHVT

Note: It is only necessary to do this test if *all* of the following conditions are met: 1) Symptom is low or missing high voltage or focus voltage, 2) The B+ and PPV voltages at the horizontal output transistor are normal and 3) The flyback passes the Ringer test.

1. Remove AC power from the monitor.
2. Discharge the CRT high voltage and remove the HV lead.

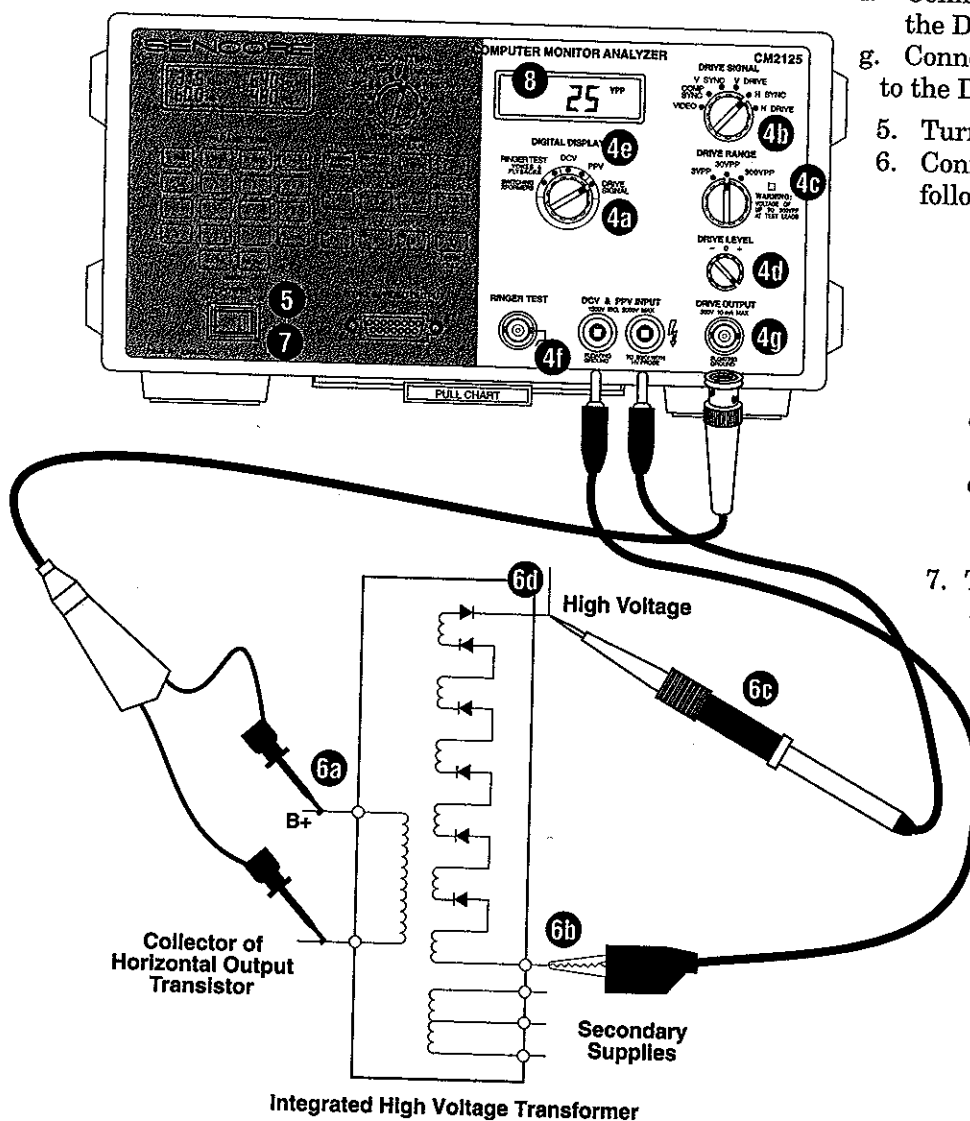

3. Remove the IHVT from the circuit or disconnect the IHVT from the circuit as needed to get a "Good" Ringer test.
4. Set the CM2125 as follows:
 - a. DIGITAL DISPLAY Switch to "Drive Signal."
 - b. DRIVE SIGNAL Switch to "H Sync."
 - c. DRIVE RANGE Control to "30 VPP."
 - d. DRIVE LEVEL Control to "+ 25 VPP."
 - e. DIGITAL DISPLAY Switch to "DCV."
 - f. Connect the DVM TEST LEAD to the DCV & PPV INPUT Jack.
 - g. Connect the DIRECT TEST LEAD to the DRIVE OUTPUT Jack.
5. Turn off the CM2125.
6. Connect the CM2125 to the IHVT as follows:
 - a. DIRECT TEST LEAD to the primary winding.
 - b. Black DVM TEST LEAD to the low side of the high voltage secondary winding ("HV resupply").
 - c. Place the TP212 on the Red DVM TEST LEAD.
 - d. Connect the Red DVM Lead & TP212 to the high voltage lead.
7. Turn on the CM2125.
8. Read the voltage in the DIGITAL DISPLAY Readout and multiply the reading by 10 to compensate for the TP212.

Fig. 58 - Testing the multiplier section of an IHVT.

What to expect: Compare the DC voltage reading to values in Table 3. If the voltage reading is below the value shown, change the DRIVE LEVEL polarity to - 25 VPP. If the reading is still low, the IHVT is bad. If the voltage reading is equal to or above the value shown in the chart, the IHVT is good.

Note: To test the focus tap, measure the DC voltage on the focus output lead or pin. A good focus supply will produce 20-35% of the voltage measured at the HV lead.

COLLECTOR PPV	CRT HIGH VOLTAGE					
	10000	15000	20000	25000	30000	35000
100	2500	3750	5000	6250	7500	8750
200	1250	1875	2500	3125	3750	4375
300	833	1250	1667	2083	2500	2917
400	625	938	1250	1563	1875	2188
500	500	750	1000	1250	1500	1750
600	417	625	833	1042	1250	1458
700	357	536	714	893	1071	1250
800	313	469	625	781	938	1094
900	278	417	556	694	833	972
1000	250	375	500	625	750	875
1100	227	341	455	568	682	795

Table 3 Use the ratio between the peak-to-peak voltage of the horizontal output transistor and the normal high voltage to determine the DC voltage for the integrated flyback test.

Testing High Voltage Multipliers

Some monitors use a high voltage multiplier that is a separate component from the flyback transformer. Typically, high voltage multipliers are doublers, triplers or quadruplers. The procedure for testing these components is similar to testing the high voltage diodes in an IHVT.

Example: Testing discrete high voltage multipliers:

1. Remove AC power from the monitor.
2. Discharge the CRT high voltage and remove the HV lead.
3. Remove the multiplier from the circuit.
4. Set the CM2125 as follows:
 - a. DIGITAL DISPLAY Switch to "Drive Signal."
 - b. DRIVE SIGNAL Switch to "H Sync."
 - c. DRIVE RANGE Control to "300 VPP."
 - d. DRIVE LEVEL Control to + 250 VPP.

- e. DIGITAL DISPLAY Switch to "DCV."
 - f. Connect the DVM TEST LEAD to the DCV & PPV INPUT Jack.
 - g. Connect the DIRECT TEST LEAD to the DRIVE OUTPUT Jack.
5. Turn off the CM2125.
 6. Connect the CM2125 to the multiplier as follows:
 - a. DIRECT TEST LEAD to the input pins.
 - b. Black DVM TEST LEAD to the ground pin.
 - c. Place the TP212 on the Red DVM TEST LEAD.
 - d. Connect the Red DVM Lead & TP212 to the high voltage lead.
 7. Turn on the CM2125.
 8. Read the voltage in the DIGITAL DISPLAY Readout and multiply the reading by 10 to compensate for the TP212.

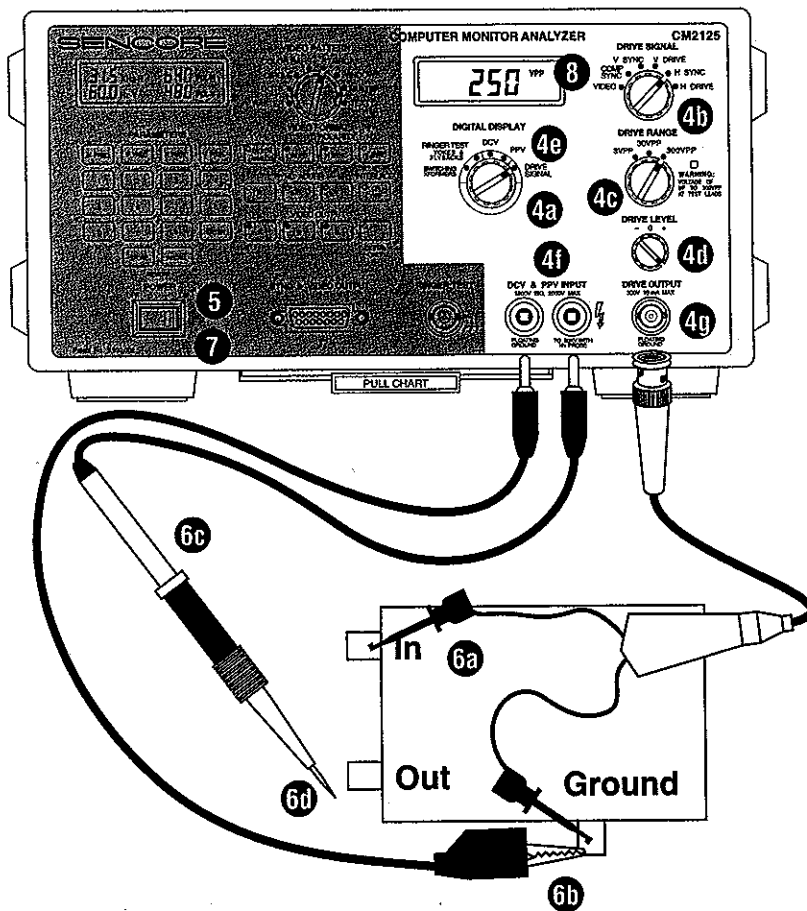

Fig. 59 - Testing a high voltage multiplier.

What to expect: Compare the DC voltage reading to the values listed in the table below. If the DC voltage reading is below the amount listed, change the DRIVE LEVEL polarity to -250 VPP. If the reading is still low, the multiplier is bad. If the voltage reading is equal to or above the value shown in the chart, the multiplier is good.

Note: To test the focus tap, measure the DC voltage on the focus output lead or pin. A good focus supply will produce 25-50% of the voltage measured at the HV lead. If the multiplier has a CTL pin, connect the CTL pin to the ground or common pin before measuring the voltage. In this case, the voltage should be 10-20% of the voltage measured on the HV lead.

Multiplier Type	Multiply Factor	Output Voltage
Doubler	2	250
Tripler	3	500
Quadrupler	4	750

Table 4 A high voltage multiplier should produce these voltages or higher when supplying 250 VPP to the input.

Testing High Voltage Regulation

The high voltage regulator circuit is responsible for maintaining a constant high voltage at the CRT as the HV load varies. A black raster turns the guns off, so there is minimum beam current and minimum load. The heaviest load is produced by a white raster. Without regulation, the high voltage would vary with displayed image. Poor high voltage regulation creates problems such as blooming, improper brightness variations, poor focus, poor color and a jumpy display.

Use the CM2125's RASTER pattern to dynamically test a monitor's high voltage regulation circuit. Quickly switching the "Video" FORMAT Button between "+" and "-" causes the display to alternate between white (maximum load) and black (minimum load).

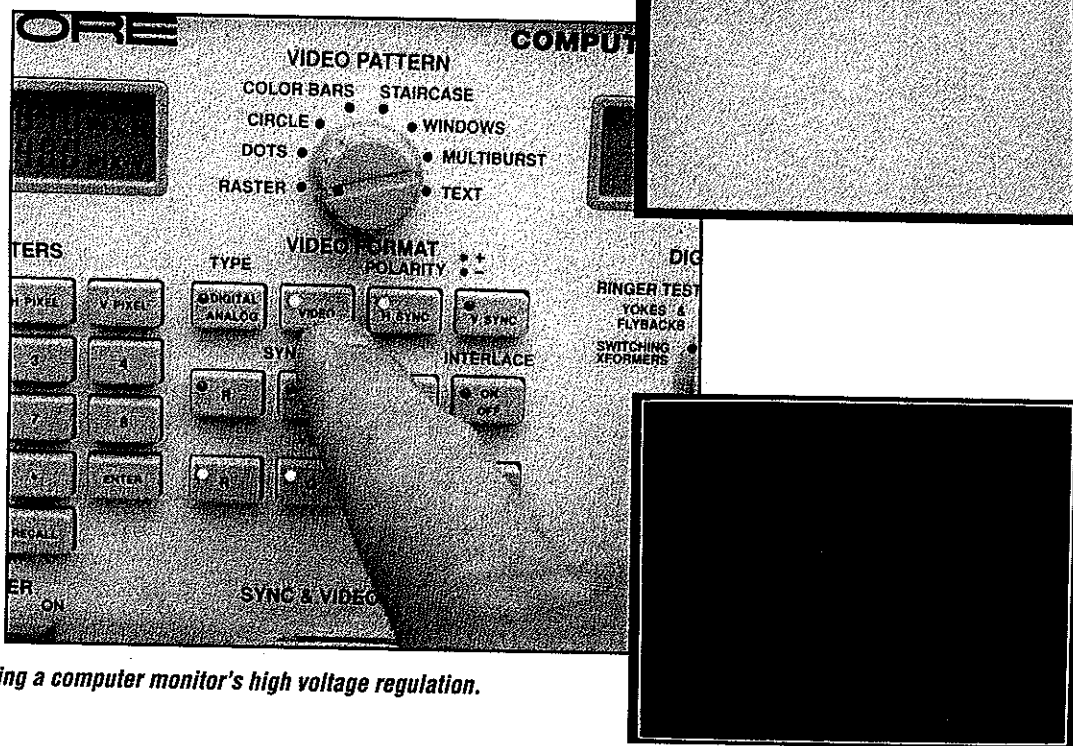

Fig. 60 - Testing a computer monitor's high voltage regulation.

Example: Testing a monitor's high voltage regulation.

1. Set the CM2125 to match the monitor type being serviced (see "Connecting To A Monitor" pages 10-19).
2. Set the VIDEO PATTERN Switch to "Raster."
3. Press R G B to "on".
4. Set the monitor's brightness to maximum.
5. Quickly press VIDEO from "+" to "-".

What to expect: The display should remain stable as it is switched between the white raster and black raster. The white border line should remain stable with no signs of bowing or blooming.

If the display shows a regulation problem, measure the peak-to-peak voltage at the collector of the horizontal output transistor while repeating step 5. If the PPV voltage changes widely with the changing video pattern, troubleshoot the B+ regulator circuit. If the PPV voltage remains stable, check the video or sync circuits for changing levels.

Troubleshooting Horizontal Drive Circuits

If the horizontal yoke, flyback, multiplier, horizontal output transistor, and B+ supply have been tested and found to be good, but the monitor still has no deflection or high voltage, the horizontal driver circuit may be defective. A missing or reduced amplitude horizontal drive signal could prevent the computer monitor from starting up and operating properly. Use the CM2125's "H Drive" to isolate problems in the horizontal drive circuit.

Example: Troubleshooting a "no high voltage" or horizontal deflection problem:

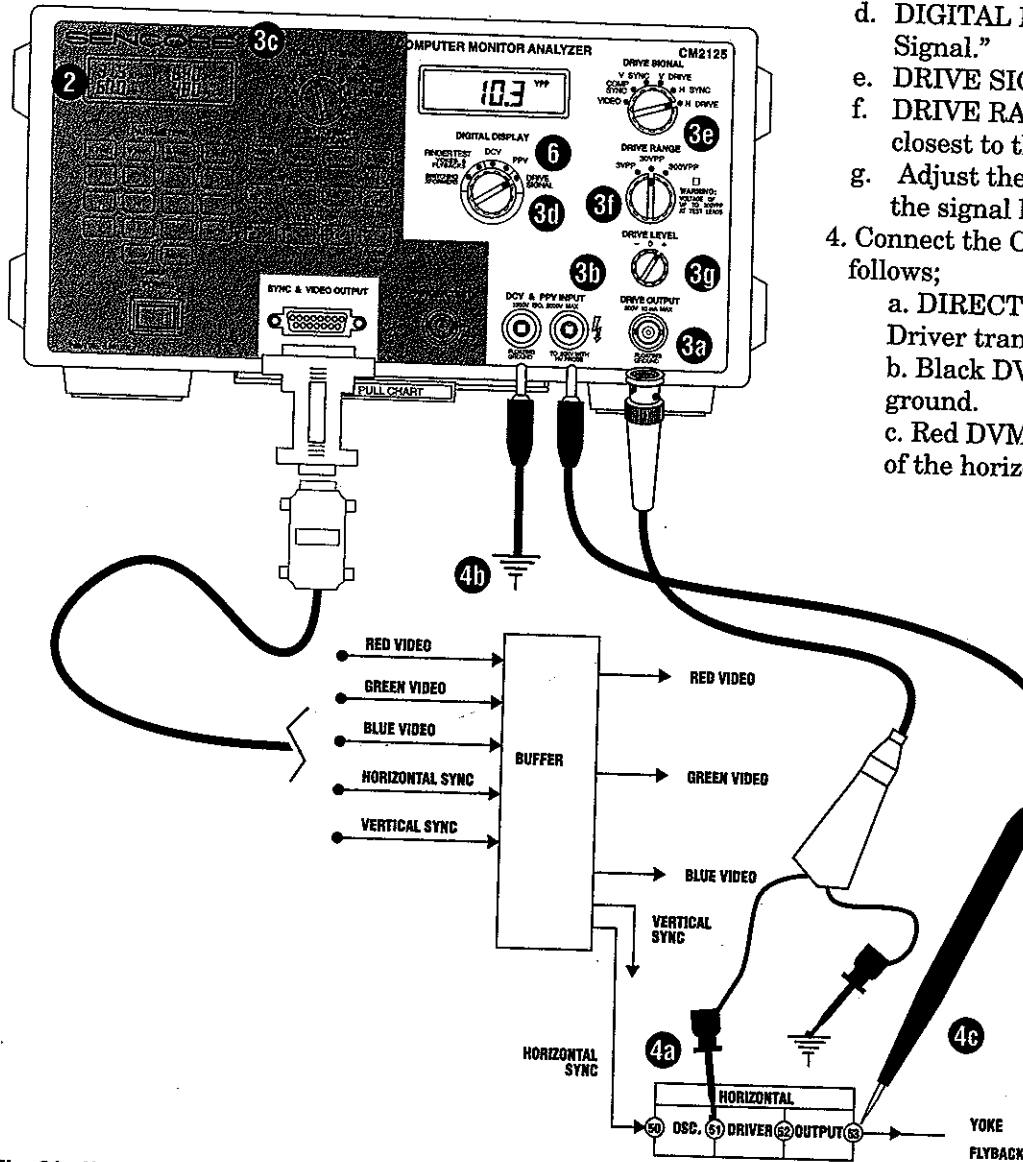

Fig. 61 - Horizontal drive circuit troubleshooting.

Notes: 1). Before injecting into the horizontal drive circuit, test the flyback and yoke, the high voltage multiplier, the horizontal output transistor, and the B+ supply and 2). When injecting the H DRIVE signal into the horizontal drive circuit always lower the line voltage to 85 volts AC.

1. Turn the monitor POWER to "Off."
2. Set the CM2125 to match the monitor type being serviced (see "Connecting To A Monitor" pages 10-19).
3. Set the CM2125 as follows:
 - a. Connect DIRECT TEST LEAD to the DRIVE OUTPUT Jack.
 - b. Connect DVM TEST LEAD to DCV & PPV INPUT Jack.
 - c. VIDEO PATTERN Switch to "Color Bars."
 - d. DIGITAL DISPLAY Switch to "Drive Signal."
 - e. DRIVE SIGNAL Switch to "H Drive."
 - f. DRIVE RANGE Control to range that is closest to the signal level in the circuit.
 - g. Adjust the DRIVE LEVEL Control to match the signal level found in the circuit.
4. Connect the CM2125 to the monitor as follows;
 - a. DIRECT TEST LEAD to base of the Driver transistor (TP 51).
 - b. Black DVM TEST LEAD to circuit ground.
 - c. Red DVM TEST LEAD to the collector of the horizontal output transistor.
5. Set the AC voltage to 85 VAC and turn "On" the monitor POWER.
6. Monitor the PPV level on the DIGITAL DISPLAY Readout as you adjust the DRIVE LEVEL Control.

What to expect: Watch for voltage on the CM2125's PPV meter and for horizontal deflection. If these return, you are injecting after the defective stage. If pulses do not occur at the collector, inject the Drive Signal at the base of the horizontal output transistor.

Note: When injecting at the output transistor, disconnect the secondary winding of the driver transformer from the base of the output transistor.

Monitoring The Horizontal Output Transistor Collector

A wealth of troubleshooting information can be gained about the monitor's operation by measuring the DC and peak-to-peak voltage at the collector of the horizontal output transistor. The DC reading tells you if the B+ supply is working correctly, while the peak-to-peak reading tells you if the output circuits are creating the needed high voltage.

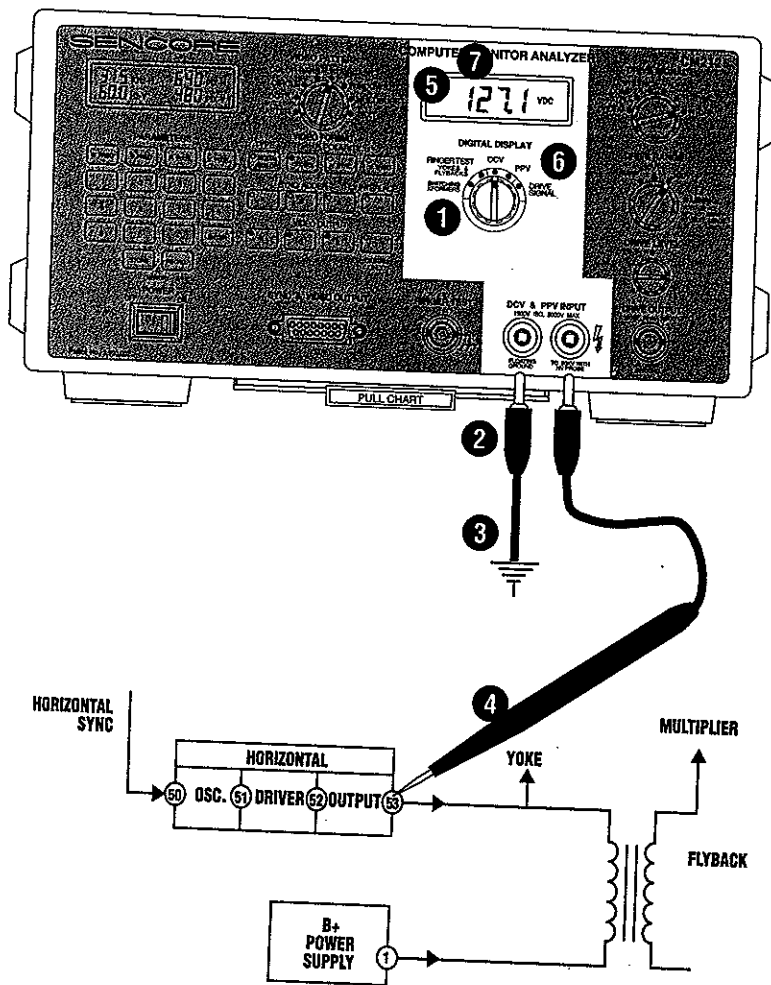

Fig. 62 - Monitoring the voltage at the collector of the horizontal output transistor.

Example: Measuring DC and peak-to-peak volts at the collector of the horizontal output transistor.

1. Set the DIGITAL DISPLAY control to "DCV".
2. Connect the DVM TEST LEADS to the DCV & PPV INPUT Jacks.
3. Connect the black DCV & PPV INPUT test lead to ground.
4. Connect the red DCV & PPV INPUT test lead to the collector of the horizontal output transistor.
5. Take the voltage reading.
6. Set the DIGITAL DISPLAY control to "PPV".
7. Take the voltage reading.

What to expect: Compare the voltage readings to those shown on the schematic. If the B+ voltage is low, unload the power supply by disconnecting the collector of the horizontal output transistor from the circuit. Measure the voltage at the output of the power supply regulator again. If the voltage is still low or missing, troubleshoot the power supply. If the voltage goes to its schematic value, something is loading down the supply. Troubleshoot the output transistor, flyback, or yoke.

If the peak-to-peak voltage reading is missing or low, troubleshoot the output transistor, flyback or yoke. If the voltage is high, check the high voltage regulation circuit, or the timing capacitors in the horizontal output circuit.

Measuring High Voltage

The CRT requires a very high DC voltage to accelerate the electrons toward the screen. This voltage is developed by the secondary winding of the flyback transformer and is rectified by the integrated diodes in the flyback, or by a separate multiplier circuit.

Measuring the high voltage at the second anode of the CRT lets you know if the output circuit, flyback, high voltage multiplier, and power supply regulation circuits are working correctly. Additionally, some monitors have adjustments to set the high voltage and focus voltage.

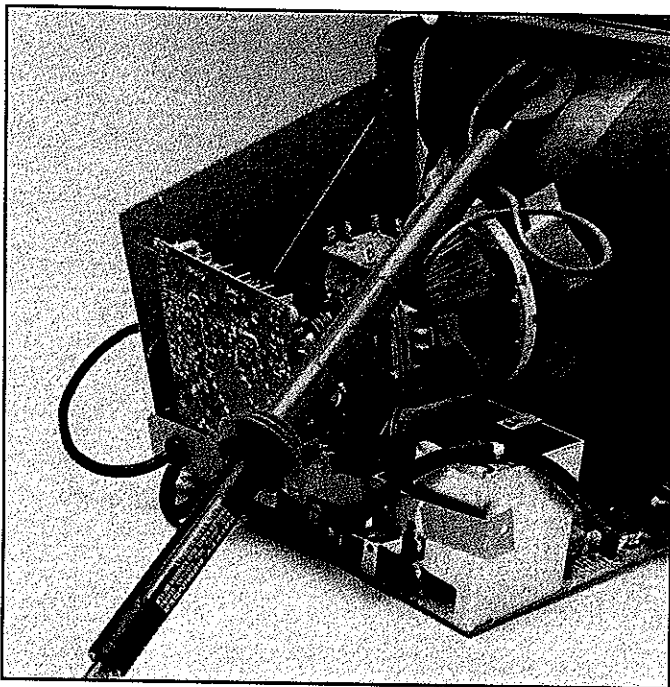

Fig. 63 - Use caution when measuring high voltage with the HP200, 50,000 volt high voltage probe.

WARNING

Measuring the high voltage exposes you to the possibility of a severe shock hazard if you do not follow careful test methods. Do not do the high voltage test until you completely read and understand the following warnings and instructions.

- 1. Never measure more than 2000 volts without a high voltage probe.** Use the TP212 to measure voltages in the 2,000 to 10,000 volt range. Use the HP200 for voltages near or over 10,000 volts.
 - 2. Remove power to the circuit before connecting to the test point or before disconnecting the high voltage probe.**
 - 3. Connect the ground lead so that it cannot become detached during the test.** If the ground lead becomes loose, remove the AC power to the monitor immediately.
 - 4. Connect to the correct ground point.** Some chassis use a separate ground for the high voltage.
 - 5. Immediately remove power to the circuit if the high voltage probe comes loose.** Do not touch the high voltage probe until power is removed and the high voltage discharged.
 - 6. If you must hold the high voltage probe, use extreme caution.** Be sure the connections to the probe and ground lead are firmly attached. Hold the probe behind the molded safety rings to prevent the possibility of contacting the high voltage test point or to prevent arcing across the probe to your body.
-

Example: Measuring a monitor's high voltage.

1. Turn off the Power to the monitor.
2. Set the CM2125 DIGITAL DISPLAY Switch to "DCV."
3. Connect the DVM TEST LEADS to the DCV & PPV INPUT Jacks.
4. Slide the red DVM TEST LEAD into the HP200 High Voltage Probe.

5. Connect black DVM TEST LEAD to the HV ground point.
6. Connect the probe to the test point so that it does not need to be held during the measurement.
7. Turn on the monitor and take the voltage reading.
8. Multiply the reading on the digital display by 100 when using the Sencore HP200.
9. Turn off the monitor before disconnecting the HP200.

Note: Be sure the tip is firmly seated in the connector inside the probe so that it will not detach during the measurement.

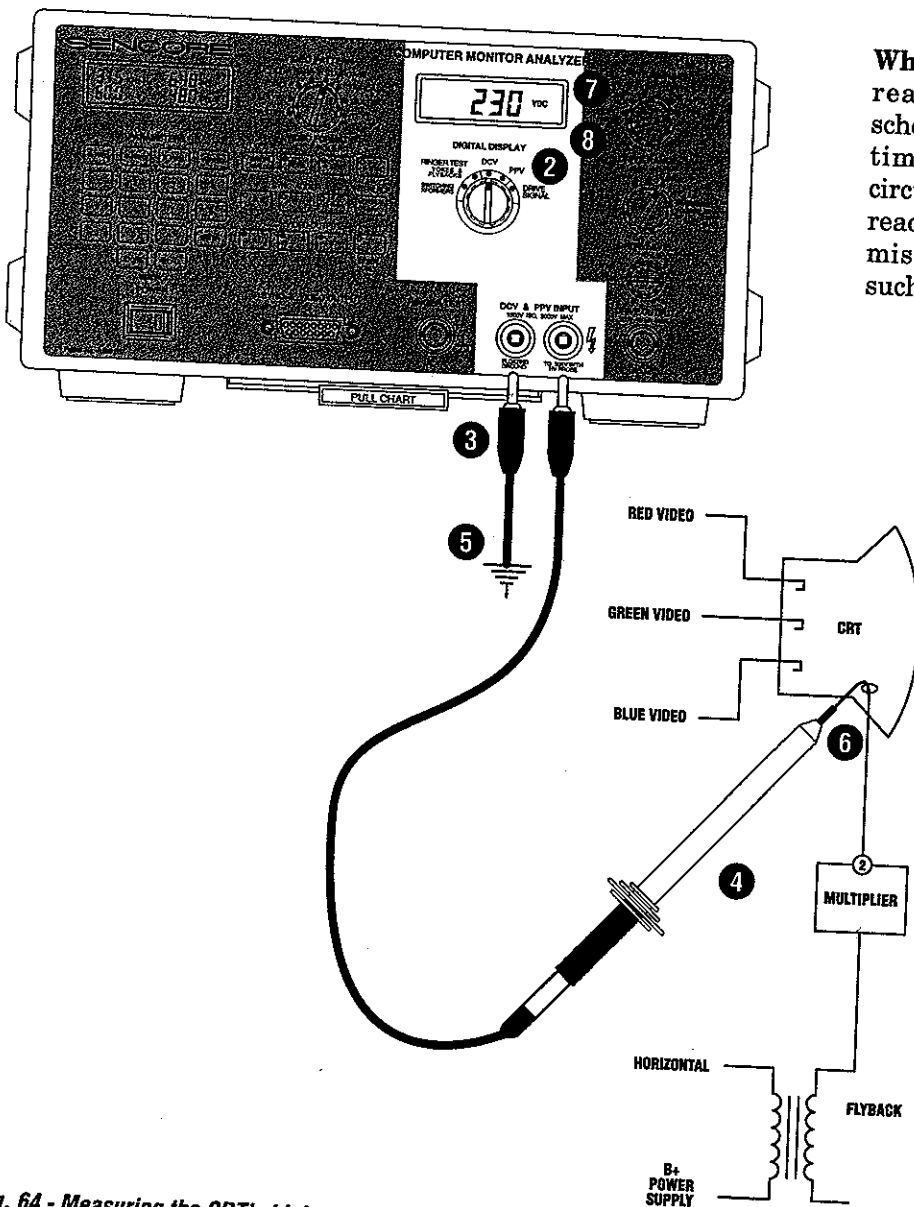

What to expect: Compare the high voltage reading to the voltage shown on the schematic. If the reading is high, check for a timing problem in the horizontal output circuit, or for a B+ regulation problem. If the reading is low or missing, check for a low or missing B+ supply, or a faulty component such as the IHVT or high voltage multiplier.

Fig. 64 - Measuring the CRT's high voltage.

"Burning In" A Monitor

After you've completed a monitor repair you may want to "burn in" the unit for a number of hours to make sure no problems surface. If a monitor displays the same pattern for an extended period of time, you run the risk of burning the phosphor in the CRT. To avoid the problem, the CM2125 can be programmed to automatically sequence through each of its video patterns. Each pattern is displayed 15 seconds.

Example: Programming the CM2125 to automatically sequence through each of its patterns.

1. Set the CM2125 to match the monitor type being serviced (see "Connecting To A Monitor" pages 10-19).

2. Press

To stop the video patterns from sequencing:

3. Press

Note: The CM2125 will not be in the video pattern sequence mode if it is shut off and turned back on again.

APPENDIX A:

CM2125 Connector Chart

Connector	Computer Monitor Type
1	CGA, MDA, Hercules
2	EGA
3	PGC
4A	VGA, PS/2, SVGA, XGA
6	BNC Input
7	13 W3
8 & 8F*	Apple® or Macintosh®
Universal	Adapts to match any computer monitor type

* Monitor with male input connection

APPENDIX B:

CM2125 Sync & Video Output Pin Configuration

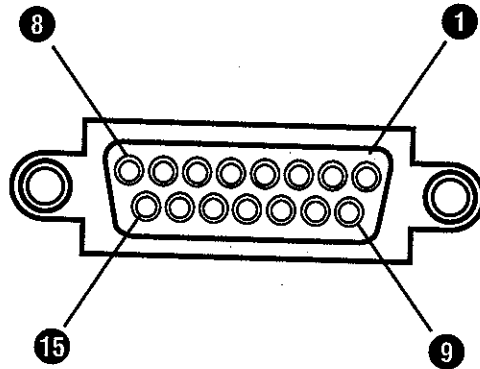

PIN #	OUTPUT	
1	RED	RED
2	GREEN	GREEN
3	BLUE	BLUE
4	INTENSITY	
5	INTENSITY	
6	H SYNC	GRAY
7	COMP SYNC	WHITE
8	GND	BLK
9	RED GND	BLK
10	GREEN GND	BLK
11	BLUE GND	BLK
12	INTENSITY	
13	GND	BLK
14	V SYNC	VIOLET
15	+5 MODE	

APPENDIX C:

Connector Pin Configurations

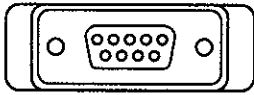

CONNECTOR #1 CGA
MDA.
HERCULES

PIN #	SIGNAL
1	GND
2	GND
3	RED
4	GREEN
5	BLUE
6	INTENSITY
7	GREEN
8	H SYNC
9	SYNC

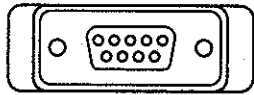

CONNECTOR #2 EGA

PIN #	SIGNAL
1	GND
2	INTENSITY
3	RED
4	GREEN
5	BLUE
6	INTENSITY
7	INTENSITY
8	H SYNC
9	V SYNC

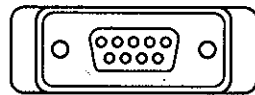

CONNECTOR #3 PGC

PIN #	SIGNAL
1	RED
2	GREEN
3	BLUE
4	COMP SYNC
5	NC
6	RED GND
7	GREEN GND
8	BLUE GND
9	NC

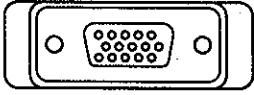

CONNECTOR #4 VGA, SVGA
PS/2, XGA

PIN #	SIGNAL
1	RED
2	GREEN
3	BLUE
4	NC
5	GND
6	RED GND
7	GREEN GND
8	BLUE GND
9	NC
10	GND
11	NC
12	NC
13	H SYNC
14	SYNC
15	NC

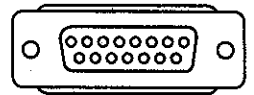

CONNECTOR #8 & 8F APPLE,
MAC

PIN #	SIGNAL
1	RED GND
2	RED
3	COMP SYNC
4	NC
5	GREEN
6	GREEN GND
7	NC
8	NC
9	BLUE
10	NC
11	GND
12	V SYNC
13	BLUE GND
14	GND
15	H SYNC

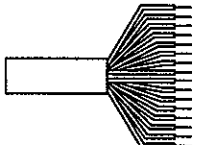

UNIVERSAL

SIGNAL	COLOR
RED	BROWN
GREEN	RED
BLUE	ORANGE
INTENSITY	PINK
INTENSITY	YELLOW
H SYNC	GREEN
COMP SYNC	LIGHT GREEN
GND	BLUE
RED GND	PURPLE
GREEN GND	SLATE
BLUE GND	WHITE
INTENSITY	BLACK
GND	BROWN/WHITE
V SYNC	RED/WHITE
+5 MODE	BLACK/WHITE

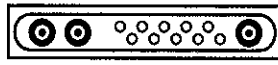

CONNECTOR #7 - 13W3

PIN #	SIGNAL
A1	RED
A2	GREEN
A3	BLUE
1	GND
2	V SYNC
3	NC
4	GND
5	C SYNC
6	H SYNC
7	GND
8	NC
9	NC
10	CASE GND

APPENDIX D:

Computer Monitor Formats

Monitor Type	H FREQ	V FREQ	H PIXEL	V PIXEL	DIGITAL ANALOG	H SYNC	V SYNC	Sync Adder	Interlace
CGA	15.7	60.0	640	200	DIGITAL				
NEC DH	16.0	60.3	640	200	DIGITAL	+	+	OFF	OFF
HITACHI 2	17.3	62.4	512	512	DIGITAL	+	-	OFF	OFF
HERCULES	18.4	50.0	720	350	ANALOG	+	-	OFF	ON
MDA	18.4	50.0	720	350	DIGITAL	+	-	OFF	OFF
EGA	21.8	60.0	640	350	DIGITAL	+	-	OFF	OFF
NEC P2	24.8	56.4	640	400	DIGITAL	+	-	OFF	OFF
PGC	30.5	60.0	640	400	DIGITAL	-	-	OFF	OFF
PGC	30.5	60.0	640	480	ANALOG	COMPOSITE SYNC		OFF	OFF
NEC P1	31.5	59.4	720	480	ANALOG	COMPOSITE SYNC		OFF	OFF
MCGA	31.5	60.0	640	480	ANALOG	-	-	OFF	OFF
VGA 3	31.5	60.0	640	480	ANALOG	-	-	OFF	OFF
NEC 3D+	31.5	60.1	640	480	ANALOG	-	-	OFF	OFF
MCGA	31.5	70.1	720	400	ANALOG	+	+	OFF	OFF
VGA 1	31.5	70.1	640	350	ANALOG	-	+	OFF	OFF
VGA 2	31.5	70.1	720	400	ANALOG	+	-	OFF	OFF
SUPER VGA	35.2	56.0	800	600	ANALOG	-	+	OFF	OFF
8514A	35.2	87.0	1024	768	ANALOG	+	+	OFF	OFF
XGA	35.2	87.0	1024	768	ANALOG	+	+	OFF	ON
MAC II	35.5	67.0	640	480	ANALOG	+	+	OFF	ON
HITACHI 1	48.4	60.0	1387	768	ANALOG	-	-	GREEN	OFF
SUPER MAC	48.8	60.0	1024	768	ANALOG	-	-	GREEN	OFF
8508 2	70.7	82.2	736	828	ANALOG	-	-	GREEN	OFF
8508 1	70.7	93.5	736	736	ANALOG	-	+	OFF	OFF
					ANALOG	+	-	OFF	OFF

APPENDIX E:

CM2125
Computer Monitor Setup Storage Locations

RECALL	FORMAT	HORIZ FREQ. (kHz)	VERT. FREQ. (Hz)	HORIZ. PIX	VERT. PIX	Connector	
0	CGA, EGA LO	640x200/60Hz	15.8	60.5	640	200	1
1	MDA, HERCULES	720x350/50Hz	18.4	50.0	720	350	1
2	EGA, HI	640x350/60Hz	21.8	60.0	640	350	2
3	PGC 1	640x400/60Hz	30.5	60.0	640	400	3
4	PGC 2	640x480/60Hz	30.5	60.0	640	480	3
5	VGA 1	640x350/70Hz	31.5	70.1	640	350	4
6	VGA 2, MCGA 1	720x400/70Hz	31.5	70.1	720	400	4
7	VGA 3, MCGA 2	640x480/60Hz	31.5	60.0	640	480	4
8	SVGA	800x600/56Hz	35.2	56.0	800	600	4
9	8514A, XGA	1024x768/87Hz	35.5	87.0	1024	768	4
10	MAC	640x480/67Hz	35.0	67.0	640	480	5
11	Generic	1024x768/60Hz	48.4	60.5	1024	768	4
12	Apollo	1280x1024/60Hz	64.0	60.0	1280	1024	6
13	DEC	1024x768/60Hz	54.9	60.0	1024	874	6
14	SUN	1152x900/66Hz	61.8	66.0	1152	900	6
15	IBM, Apollo	1280x1024/60Hz	63.4	60.0	1280	1024	6
16	Apollo	1024x800/76Hz	64.0	76.0	1024	800	6
17	IBM	1360x1024/67Hz	70.8	67.0	1360	1024	6
18	Apollo	1280x1024/70Hz	75.1	70.0	1280	1024	6
19	Radius	1152x882/72Hz	66.0	72.0	1152	882	6
20	Radius/MAC port.	640x870/75Hz	68.9	75.0	640	870	6
21	Radius/MAC	1152x870/75Hz	68.7	75.0	1152	870	-
22	Radius	1152x870/72Hz	64.8	72.0	1152	870	-
23	Apollo	1280x1024/64Hz	68.2	64.0	1280	1024	-

1492

BAULY

ODYSSEY
I-GAME
PRINCETON

CONAMI

8 SVGA 800x600/60Hz 37.9 60.00

Continued on next page

**CM2125
Computer Monitor Setup Storage Locations**

RECALL	FORMAT	HORIZ FREQ. (kHz)	VERT. FREQ. (Hz)	HORIZ. PIX	VERT. PIX	Connector	
24	SUN	1600x1280/67Hz	89.2	66.9	1600	1280	-
25	MAC	832x624/75Hz	49.7	74.6	832	624	-
26	SuperMac	1024x768/75Hz	60.2	75.0	1024	768	-
27	NTSC Mono Video Monitor		15.8	60.0	640	242	-
28	VESA	640x480/72Hz	37.9	72.0	640	480	-
29	VESA	800x600/60Hz	37.9	60.0	800	600	-
30	VESA	800x600/72Hz	48.1	72.0	800	600	-
31	VESA	1024x768/60Hz	48.4	60.0	1024	768	-
32	VESA	1024x768/70Hz	56.5	70.0	1024	768	-
33	XGA-2	720x350/88Hz	39.4	87.9	720	350	-
34	XGA-2	720x400/88Hz	39.4	87.9	720	400	-
35	XGA-2	640x480/75Hz	39.4	75.0	640	480	-
36	XGA-2	1024x768/75Hz	61.1	75.0	1024	768	-
37	Sony	1024x768/60Hz	48.8	60.0	1024	768	-
38	Sony	1152x900/66Hz	61.8	66.0	1152	900	-
39	Sony	1280x1024/60Hz	63.3	60.0	1280	1024	-
40	Samsung	1006x1048/60Hz	62.8	59.8	1006	1048	-
41	DEC	1024x864/60Hz	54.0	60.0	1024	864	-
42	DEC	1280x1024/60Hz	70.7	66.5	1280	1024	-
43-69	User Definable						-
99	15 Second Pattern Sequence						-

APPENDIX F:

VIDEO OUTPUT COLOR COMBINATIONS

DIGITAL MONITORS

COLOR	R	G	B	I
Black	0	0	0	0
Blue	0	0	1	0
Green	0	1	0	0
Cyan	0	1	1	0
Red	1	0	0	0
Magenta	1	0	1	0
Brown	1	1	0	0
White	1	1	1	0
Dark Gray	0	0	0	1
Light Blue	0	0	1	1
Light Green	0	1	0	1
Light Cyan	0	1	1	1
Light Red	1	0	0	1
Lt. Magenta	1	0	1	1
Yellow	1	1	0	1
Intense White	1	1	1	1

ANALOG MONITORS

COLOR	R	G	B
Black	0	0	0
Blue	0	0	1
Green	0	1	0
Cyan	0	1	1
Red	1	0	0
Magenta	1	0	1
Brown	1	1	0
White	1	1	1

APPENDIX G:

Calculating A Monitor's Bandwidth

A monitor's bandwidth is determined by its ability to display a sharp, crisp picture. The higher the bandwidth, the more resolution and clarity appears in the picture. A monitor's bandwidth is best checked with a pattern that produces lines that are a single pixel wide (a pixel is the smallest picture element possible).

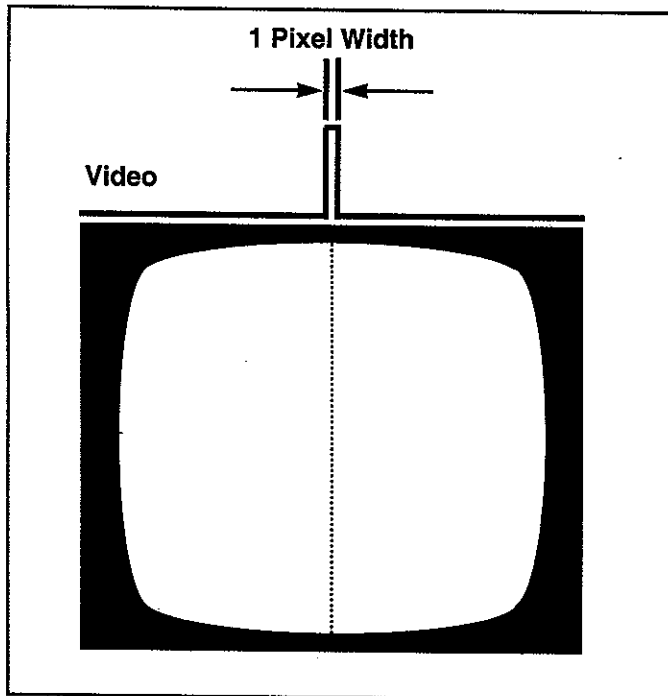

Fig. 65 - A one pixel wide line is best suited for testing a monitor's maximum bandwidth. A crisp, distinct line shows that the monitor has the bandwidth needed to "turn on" a single pixel at a time.

For an example let's calculate the required bandwidth of a VGA monitor. The VGA standard has 640 horizontal pixels and the horizontal scanning frequency is 31.5 kHz.

Inverting the horizontal scanning frequency gives a total horizontal scan time of 31.7 micro-seconds. About 80% of this time is active video (what's seen on the monitor) and about 20% is blanking. So 25.4 micro-seconds is active video and 6.3 micro-seconds is blanking.

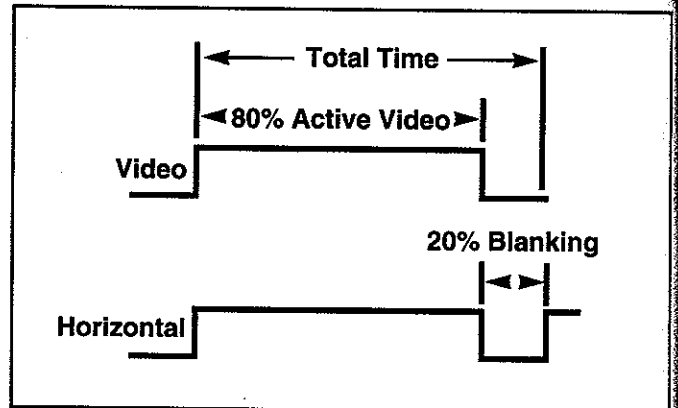

Fig. 66 - One scan line is made up of active video and blanking.

If 640 pixels must be fit into the 25.4 micro-second active display time, we can find the amount of time it takes to turn on one pixel by dividing 25.4 micro-seconds by 640 pixels. This shows that each pixel is on for 39.7 nano-seconds (39.7×10^{-9} seconds). If we invert 39.7 nano-seconds we get a frequency of 25.2 MHz. So in order to see a crisp, distinct line of one pixel width, the bandwidth of the video amplifiers in a VGA monitor must be 25.2 MHz or greater.

Horizontal Scan = 31.5 kHz

Total Scan Time = $1/31.5 \text{ kHz} = 31.7 \text{ usec.}$

Active Video Time = (80%) (31.7 usec.) = 25.4 usec.

Note: 640 Pixels will be displayed in 25.4 usec.

Display time per pixel = $25.4 \text{ usec.}/640 \text{ pixels} = 39.7 \text{ nanosec.}$

Bandwidth required to turn on a single pixel = $1/39.7 \times 10^{-9} = 25.2 \text{ MHz}$

Fig. 67 - Bandwidth calculation for a VGA monitor.

APPENDIX H:

Pixel Parameter Errors

The CM2125 cannot accept the sync and pixel parameter conditions when the vertical pixel value exceeds the time allotted by the horizontal and vertical scan frequency.

When this occurs, the pixel enunciator blinks and the CM2125 automatically determines and displays the maximum allowable pixel value. You can press "ENTER" to accept this value or you can enter a value lower than the one displayed.

Here's the explanation for this condition:

For example you've programmed these parameters into the CM2125:

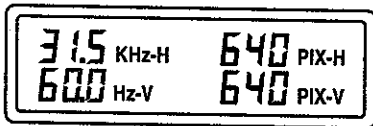

The PIX-V enunciator blinks and the vertical pixel value is 521. Here's why:

The total scan time for one full field (raster) is 16.7 mSec

$$\begin{aligned} 1/V \text{ SYNC} &= \text{scan time of one field} \\ 1/60.0 \text{ Hz} &= 16.667 \text{ mSec} \end{aligned}$$

The total scan time for one line is 31.7 uSec

$$\begin{aligned} 1/H \text{ SYNC} &= \text{scan time of one line} \\ 1/31.5 \text{ KHz} &= 31.746 \text{ uSec} \end{aligned}$$

If we divide the scan time for one field by the scan time for one line we will get the maximum number of lines that can be displayed.

$$\frac{\text{Scan time of one field}}{\text{Scan time of one line}} = \begin{matrix} \text{maximum number of lines} \\ \text{that can be displayed} \end{matrix}$$

$$\frac{16.667 \text{ mSec}}{31.746 \text{ uSec}} = 525 \text{ lines}$$

The CM2125 will display 521 PIX-V because four lines are used for vertical sync.

APPENDIX I:

Pixels, Scan Frequency And Dot Clock Frequency

Horizontal scan frequency and horizontal pixels are two parameters that work together to establish a computer monitor's dot clock frequency. Dividing the number of displayed horizontal pixels by the horizontal active video time tells you how fast the CM2125 clocks pixels out to the computer monitor.

$$\text{Dot Clock Frequency} = \frac{\text{Horizontal Pixels}}{\text{Horizontal Active Video Time}}$$

For example a computer monitor with a scanning frequency of 48 KHz (active video time of 18.75 microseconds) and a horizontal pixels resolution of 1280 has a dot clock frequency of:

$$\begin{aligned} \text{Dot Clock Frequency} &= \frac{1280}{18.75 \mu\text{Sec}} \\ &= 68.3 \text{ MHz} \end{aligned}$$

The CM2125 clocks pixels to this computer monitor at a 68 MHz rate.

Here's how pixels, scan frequency and dot clock frequency interact:

Waveform B (Fig. 68) has a faster scan frequency than waveform A. Because of this, waveform B has less active video display time.

If we keep the number of pixels constant from waveform A to B, the pixels must be clocked out faster to waveform B than waveform A (fitting the same number of pixels in less time). Hence, an increased dot clock frequency.

The CM2125 has a maximum dot clock frequency of 125 MHz. It provides a maximum horizontal and vertical pixel resolution of 2048. The CM2125 can provide up to 2048 horizontal pixels provided the monitor's horizontal scan frequency and the number of pixels don't exceed the CM2125's dot clock frequency.

The CM2125 tests all computer monitors regardless of their horizontal scan frequency and number of pixels. Even on monitors with extremely high dot clock frequencies (e.g. 300 MHz), the CM2125 provides full, centered, locked-in patterns for troubleshooting and alignment.

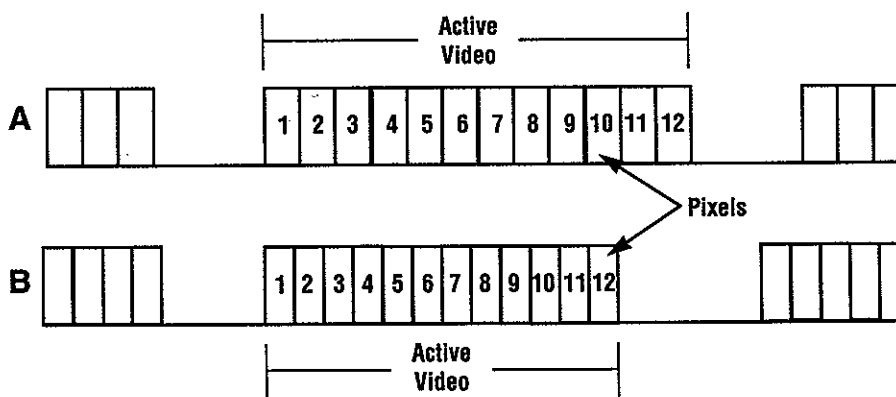
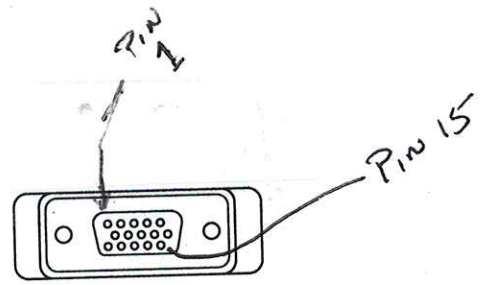
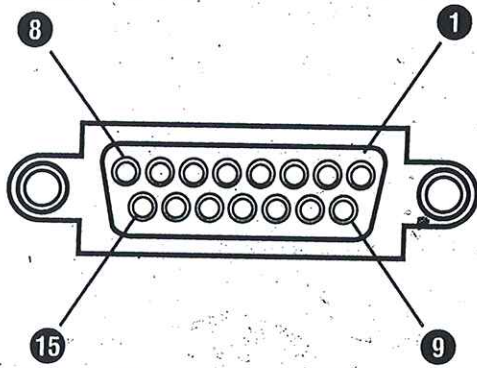

Fig. 68 - B Pixels = A Pixels B Hfreq > A Hfreq B Dot Clock > A Dot Clock



CONNECTOR #4

VGA, SVGA
PS/2, XGA

Pin 1	RED	to	RED	Pin 1
Pin 2	GREEN	to	Green	Pin 2
Pin 3	BLUE	to	Blue	Pin 3
Pin 4	INTENSITY	to	N/C	Pin 4
Pin 5	INTENSITY	to	N/C	Pin 9
Pin 6	H SYNC	to	H SYNC	Pin 13
Pin 7	COMP SYNC	to	N/C	Pin 12
pin 8	GND	to	GND	Pin 5
Pin 9	RED GND	to	RED GND	Pin 6
Pin 10	GREEN GND	to	GREEN GND	Pin 7
Pin 11	BLUE GND	to	BLUE GND	Pin 8
Pin 12	INTENSITY	to	N/C	Pin 11
Pin 13	GND	to	GND	Pin 10
Pin 14	V SYNC	to	SYNC	Pin 14
Pin 15	+.5 mode	to	N/C	Pin 15

CM2125 Sync & Video Output Pin Configuration

Using the CM2125 Computer Monitor Analyzer to Test LCD Screens

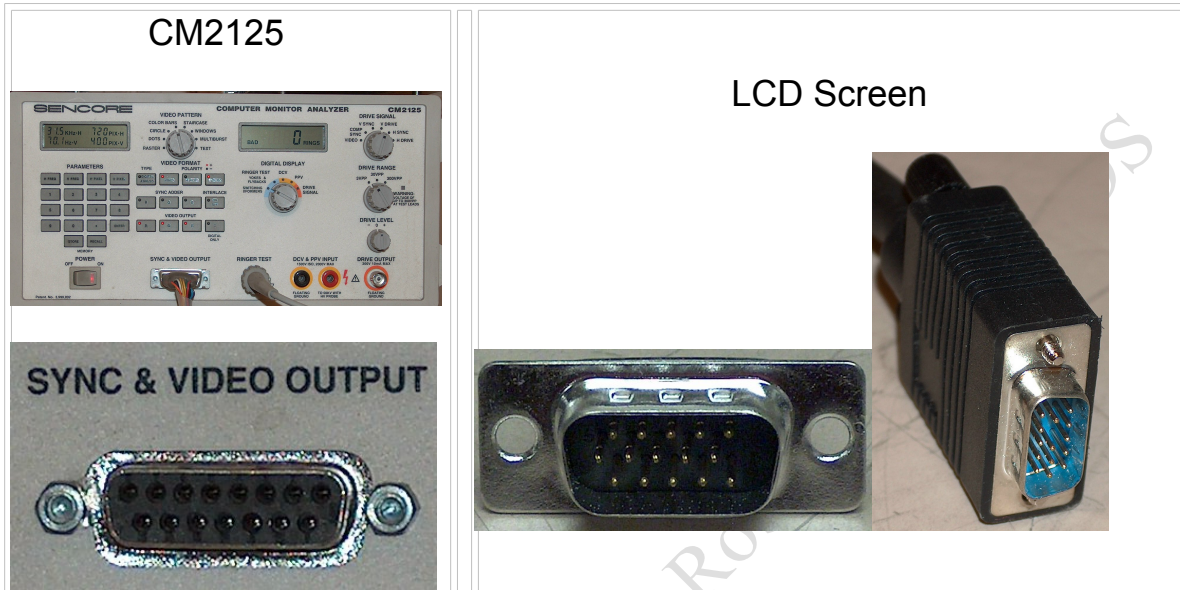

Pin 1	Red	Pin 1
Pin 2	Green	Pin 2
Pin 3	Blue	Pin 3
Pin 4	Intensity	NC
Pin 5	Intensity	NC
Pin 6	H Sync	Pin 13
Pin 7	Comp Sync	NC
Pin 8	Gnd	Pin 5, Pin 6, Pin 7, Pin 8 Pin 10
Pin 9	Red Gnd	Pin 5, Pin 6, Pin 7, Pin 8 Pin 10
Pin 10	Green Gnd	Pin 5, Pin 6, Pin 7, Pin 8 Pin 10
Pin 11	Blue Gnd	Pin 5, Pin 6, Pin 7, Pin 8 Pin 10
Pin 12	Intensity	NC
Pin 13	Gnd	Pin 5, Pin 6, Pin 7, Pin 8 Pin 10
Pin 14	V Sync	Pin 14
Pin 15	+5 mode	NC

CM2125 Settings (Recall 6 or 7)

Type	Format	Horiz	Vert Freq (Hz)	Horiz Pix	Vert Pix
------	--------	-------	----------------	-----------	----------

		Freq(kHz)			
VGA2	720x400/70Hz	31.5	70.1	720	400
VGA3	640x480/60Hz	31.5	60.0	640	480



Using the CM2125 Computer Monitor Analyzer
To test Ceronix 1490 and 1492 monitors

Ceronix 1490 / 1492

CM2125

NC	Intensity	Pin 4
NC	Intensity	Pin 5
NC	Comp Sync	Pin 7
NC	Intensity	Pin 12
NC	+5 mode	Pin 15
Pin 1	Gnd	Pin 8
Pin 1	Red Gnd	Pin 9
Pin 1	Green Gnd	Pin 10
Pin 1	Blue Gnd	Pin 11
Pin 1	Gnd	Pin 13
Pin 2	V Sync	Pin 14
Pin 3	Red	Pin 1
Pin 4	Green	Pin 2
Pin 5	Blue	Pin 3
Pin 6	H Sync	Pin 6
Pin 7	No Connection	

Pin 8	No Connection	
Pin 9	AC (White)	
Pin 10	AC (Black)	
Pin 11	Ground	
Pin 12	No Connection	
Pin 13	No Connection	
Pin 14	No Connection	
Pin 15	No Connection	
Pin 16	No Connection	
Pin 17	No Connection	
Pin 18	No Connection	
Pin 19	No Connection	

My Slot Notes (RESULT) Robert E. Sult AOS

CM2125 SPECIFICATIONS:

Outputs:

Bandwidth: 125 MHz
Horizontal pixel resolution: 80 - 2048 pixels
Vertical pixel resolution: 80 - 2048 pixels
Horizontal scan frequency: 10 - 250 KHz
Vertical scan frequency: 10 - 250 Hz
Output amplitude: TTL, analog, or ECL
Mode selection: Interlaced or non-interlaced
Gun selection: RGB
Sync adder: RGB
Polarity selection: Video, H-Sync, V-Sync

Sync Timing:

The CM2125 recognizes common computer monitor formats and automatically adjusts for the correct sync, back porch, and front porch timing.

Sync timing parameters can be changed through the front panel.

Memory:

70 computer monitor setup storage locations (42 preprogrammed).

Video Patterns:

Raster	Dots	Circle/Crosshatch
Color Bars	Multiburst	Staircase
Text	Window	Windows

Drive Signals:

Signal at zero: Less than 3% of full range

Output at full level:

3 V range: 3 VPP, ± 0.5 V into 100 ohms

30 V range: 30 VPP, ± 5 V into 100 ohms

300 V range: 300 VPP, ± 50 V into 10,000 ohms

Clipping: None up to 250 VPP typical

Protection from externally applied voltage: ± 500 V (DC + peak AC)

Floating ground (-) Isolated by ± 500 V (DC + peak AC)

External VPP:

3 ranges (auto-ranged): 0.0 - 19.9VPP, 20 - 199 VPP, 200 - 1999 VPP

Accuracy: (All) $\pm 1\%$, ± 2 counts

Frequency response: 0 - 200 V, 30 Hz to 5 MHz, $t/-1$ dB from the average value across the band

Input impedance: 15 Megohm

External VDC:

3 ranges (auto-ranged): 00.00 - 19.99 V DC, 20.0 - 199.9 V DC, 200 - 1999 V DC

Accuracy: (All) $\pm .2\%$, ± 2 counts

Input Impedance: (Without probe) 15 Megohm

Meter Protection:

2000 V DC (DC + peak AC), across the inputs. Maximum voltage between (-) lead and ground: 1500 (DC + peak AC)

Ringling Test:

Dynamic test of coil Q determined by counting the number of ringing cycles before reaching a preset damping point. The preset damping point is set at 25% of the excitation pulse. The number of cycles is displayed on the digital display and continually updated.

General:

Digital meters: 3 ½ digit, LCD readout Digital display: LCD readout

Guaranteed operating temperature: 15-35 degrees C

Size: 6" x 12" x 14.3" (HWD)

Power: 105-125 VAC, 60 Hz, 140 w max.

Supplied Accessories:

Test lead, BNC to EZ hook probes

Test lead, 72" banana-probe, red

Test lead, 72" banana-alligator, black

Optional Accessories:

Extension Cable

BNC Cable

Universal Connector (Adapts to match any computer type)

Connector #1 (CGA, MDA, Hercules)

Connector #2 (EGA)

Connector #3 (PGC)

Connector #4A (VGA, PS/2, SVGA, XGA)

Connector #6 (BNC Input)

Connector #7 (13 W3)

Connector #8 & 8F* (Apple/MAC) * Monitor with male input connection.

ECL Adapter (ECL Monitors)

IB72 IEEE-488 Interface Accessory

IB78 RS232 Interface Accessory

PC263 Protective Cover

HP200 50 kV High Voltage Probe

TP212 10 kV Transient Protector Probe